

ZT68J

Operation and Safety Manual

ZOOMLION INTELLIGENT ACCESS MACHINERY CO.,LTD.

Add:Tengfei Road 997 , Wangcheng District, Changsha, Hunan,PRC

Zip Code:410200

E-mail:awm@zoomlion.com

Tel:400-800-0157



ZOOMLION

ZOOMLION

ZT68J

Operation and Safety Manual

Jul 2021 Version A

Foreword

Zoomlion appreciates your choice of our machine for your application. The Operation and Safety Manual must be read and understood in its entirety before operating the machine.

This manual introduces you safety information, significant technical specs, safety operation in detail for working efficiency improving. Keep this manual properly at all times for looking up.

Do not operate the machine if there is any doubt in operation, please consult local service team for troubleshooting. Zoomlion AWP Machinery Company does not take the consequence of wrong operation.

This manual should be considered a permanent part of your machine and should remain with the machine at all times.

The content is under intellectual property protection, permission is required for a copy or other application.

There might be some tiny differences in detail between your machine and the upgraded one due to the continuous improving. For clarification, questions, or additional information regarding any portions of this manual, Contact Zoomlion AWP Machinery.

Our company reserves the right to modify this manual as technical improvement without notice.

Thank you for your trust and support for Zoomlion products!

Comply with ANSI SAIA_A92.20-2018 and CSA-B354.6-2017 Standard

Safety Precaution Icons

This manual has the following safety precaution icons:



Failure to comply with the safety precautions listed in this manual could result in personal injury or death.



Failure to comply with the safety precautions listed in this manual could result in potential personal injury or death.



Failure to comply with the safety precautions listed in this manual could result in potential mild personal injury.



Indicates risks unrelated with personal injury (such as property damage).

Contents

Foreword.....	I
Safety Precaution Icons.....	II
Contents	III
SECTION 1 SAFETY PRECAUTIONS	1-1
1.1 General.....	1-1
1.2 Pre-operation Caution	1-1
1.3 Hazard Classification	1-2
1.4 Intended Use	1-2
1.5 Safety Alert Symbols and Maintenance	1-2
1.6 Safety Operation	1-5
1.6.1 Operator safety.....	1-5
1.6.2 Workplace safety.....	1-5
SECTION 2 MACHINE COMPONENTS AND CONTROLS.....	2-1
2.1 Machine Components	2-1
2.2 Machine Controls and Indicators	2-2
2.2.1 Ground control console.....	2-2
2.2.2 Ground Control Indicator Panel.....	2-5
2.2.3 Platform control console.....	2-10
2.2.4 Platform control indicator panel	2-13
Section 3 MACHINE INSPECTION.....	3-1
3.1 General.....	3-1
3.1.1 Pre-Start inspection principle.....	3-1
3.1.2 Pre-start inspection	3-1
3.2 Function Test.....	3-3
3.2.1 Function test principle	3-3
3.2.2 Ground function check.....	3-3
3.2.3 Platform function check.....	3-4
3.3 Workplace Inspection.....	3-8
3.3.1 Workplace inspection principle.....	3-8
3.3.2 Workplace inspection.....	3-8
3.4 Decal Inspection.....	3-9

Contents

SECTION 4 OPERATION INSTRUCTION	4-1
4.1 General.....	4-1
4.2 Machine Operation.....	4-1
4.2.1 Engine operation	4-1
4.2.2 Drive operation	4-3
4.2.2.3 Driving.....	4-5
4.2.3 Platform leveling.....	4-5
4.2.4 Platform Rotation.....	4-5
4.2.5 Turntable Slewing.....	4-5
4.2.6 Raising and lowering the main boom	4-6
4.2.7 Telescoping the main boom	4-6
4.2.8 Raising and lowering the jib	4-6
4.2.9 Emergency stop.....	4-6
4.2.10 Auxiliary power	4-6
4.2.11 Shut down and park	4-7
4.3 Transport and Lifting	4-8
4.3.1 Release brake when towing	4-8
4.3.2 Lifting	4-9
4.3.4 Securing the platform.....	4-9
SECTION 5 MAINTENANCE	5-1
5.1 General.....	5-1
5.1.1 Maintenance symbols legend.....	5-1
5.1.2 Pre-start inspection	5-1
5.1.3 Maintenance hazards.....	5-2
5.1.4 Body injury hazard.....	5-2
5.2 Power and Hydraulic System Maintenance	5-3
5.2.1 Check the engine oil level.....	5-3
5.2.2 Diesel requirements	5-3
5.2.3 Check the engine coolant level	5-4
5.2.4 Check hydraulic oil.....	5-4
5.3 Battery Maintenance	5-7
5.4 Regular Maintenance	5-9
5.4.1 Swing drive.....	5-9
5.4.2 Hydraulic reservoir	5-9

Contents

5.4.3 Drive hub	5-10
5.4.4 Replace engine oil -Deutz D447L4.....	5-11
5.4.5 Fuel filterDeutz D447L4.....	5-11
5.4.6 High pressure filter	5-12
5.4.7 Air filter	5-13
5.4.8 Engine coolant	5-13
5.5 Tire and Wheel.....	5-14
5.5.1 Tire replacement	5-14
5.5.2 Wheel and tire replacement	5-14
5.5.3 Wheel installation	5-14
 SECTION 6 STORAGE AND EX-FACTORY TEST	 6-1
6.1 Storage Conditions.....	6-1
6.2 Ex-factory Test Items	6-1
 SECTION 7 TECHNICAL PARAMETER.....	 7-1
 APPENDIX:INSPECTION AND MAINTENANCE RECORD.....	 7-3

ZOOMLION

Operation and Safety Manual

Section 1 Safety Precautions

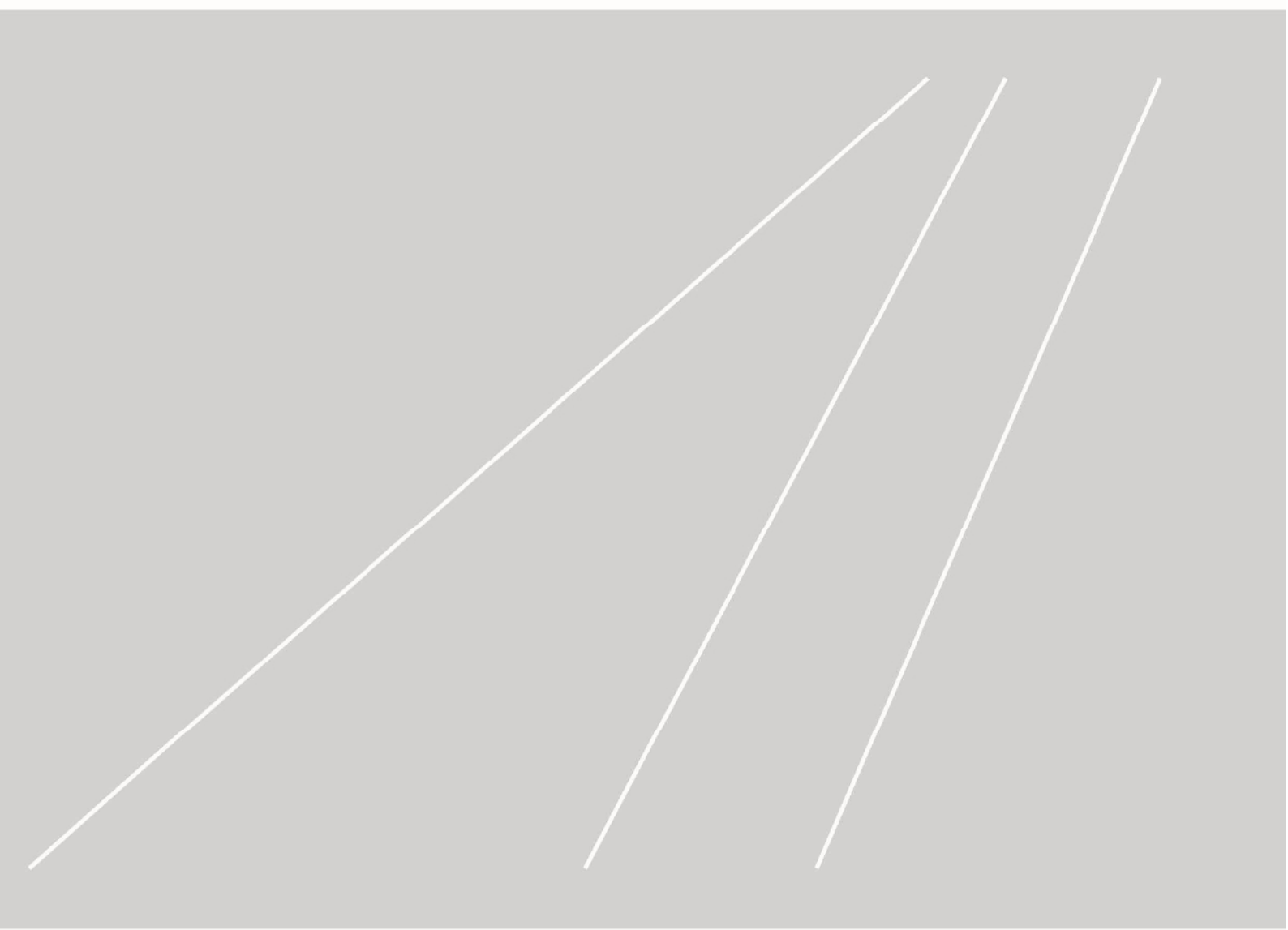

SECTION 1 SAFETY PRECAUTIONS

1.1 General

To Owners/Users/Operators:

Zoomlion appreciates your choice of our machine for your application. Our number one priority is user safety, which is best achieved by our joint efforts. The following requirements need to be adhere to for the purpose of safety operating:

- a) Obey all user rules, job site regulations and governmental regulations.
- b) Read, understand and obey all operating instructions on the machine and in this manual.
- c) Keep good safety operating conventions.
- d) Allow only those authorized and qualified personnel to operate the machine under the supervision of an experienced and qualified operator.
- e) An operator must not operate the machine if he has any doubts.

Zoomlion appreciates your choice of our machine for your application.

1.2 Pre-operation Caution



Failure to comply with the safety precautions listed in this manual could result in personal injury or death.

An operator must not operate the machine, only if:

- a) He has learned and practiced the principles of safe machine operation contained in this operational manual;
 - 1) Avoid hazardous situations.
 - 2) Be aware of safety rules before further operation.
 - 3) Perform a pre-operation inspection at all times.
 - 4) Implement functional test before operating the machine at all times.
 - 5) Inspect job site.
 - 6) Only use the machine as it was intended.
- b) Read, understand and obey the manufacturer's instructions and safety rules—safety and operator's manuals and machine decals.
- c) Read, understand and obey employer's safety rules and worksite regulations.
- d) Read, understand and obey all applicable governmental regulations.

- e) The operator is properly trained to safely operate the machine.

1.3 Hazard Classification

Decals on this machine use symbols, color coding, and signal words to identify the following:



Safety alert symbol—used to alert you to potential personal injury hazards. Obey all safety messages that follow this symbol to avoid possible injury or death.



Indicates a hazardous situation which, if not avoided, will result in death or serious injury. This decal will have a red background.



Indicates a hazardous situation which, if not avoided, could result in death or serious injury. This decal will have an orange background.



Indicates a hazardous situation which, if not avoided, could result in minor or moderate injury. This decal will have a yellow background.



Indicates a property damage message. This decal will have a blue background.

1.4 Intended Use

This machine is intended to be used only to lift personnel, along with their tools, and materials to an aerial work site.

1.5 Safety Alert Symbols and Maintenance

Replace any missing or damaged safety signs. Operator must keep safety awareness in mind at all times. Use mild soap and water to clean safety signs. Do not use solvent-based cleaners because they may damage the safety sign material.





















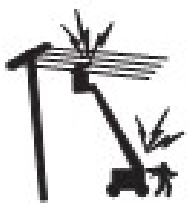



				
Read operational manual	Read service manual	Fire hazard	No smoking	Explosion hazard
				
Electrocution hazard	Burn hazard	Prohibit Step on	Avoid contact	Maintain required clearance
				
Electrocution hazard	Tip-over hazard	Tip-over hazard	Tip-over hazard	Tip-over hazard
				
Wheel load	Wind speed	Maximum capacity	Tie-down point	Lanyard anchorage points
				
Crushing hazard	Disconnect battery	Manual force	Collision Hazard	Maintain safety distance

Figure 1-1 Symbol and Hazard Pictorials Definitions



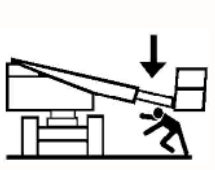







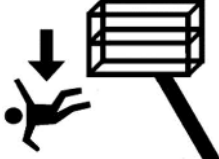



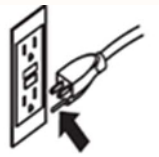

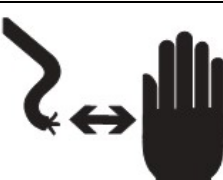
				
Runaway hazard	Fall hazard	Tire disassembly	Explosion hazard	No smoking No flame Stop engine
				
Platform AC Power	Prohibit lifting	Lifting point	Avoid contact	Trained and authorized personnel operate the machine only
Recovery procedure if tilt alarm sounds while elevated				
				
Platform uphill: 1. Lower the main boom; 2. Retract the main boom.	Platform downhill: 1. Retract the main boom 2. Lower the main boom;	Prohibit high pressure water-beaktest	Prohibit modify the limit switches	Color coded direction arrows
				
Collision Hazard	High temperature surface	Avoid contact	Fill fuel oil	Crushing hazard

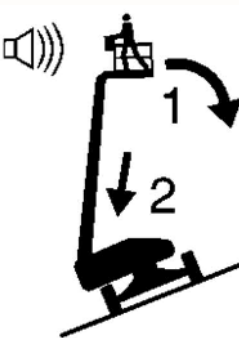
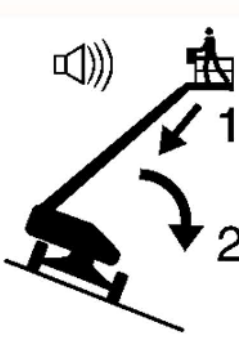
Figure 1-1 Symbol and Hazard Pictorials Definitions (continuous)

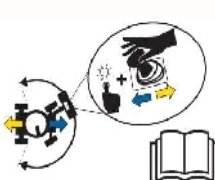
1.6 Safety Operation

1.6.1 Operator safety

Personal Fall Protection

Personal fall protection equipment (PFPE) is required when operating this machine. If PFPE is required in job site or in operator's manual, the following rule should be complied with:

All PFPE must comply with applicable governmental regulations, and must be inspected and used in accordance with the PFPE manufacturer's instructions.

1.6.2 Workplace safety



This machine is not electrically insulated and will not provide protection from contact with or proximity to electrical current.

- a) Obey all local and governmental regulations regarding required clearance from electrical power lines. At a minimum, the required clearance contained in the table below must be followed.

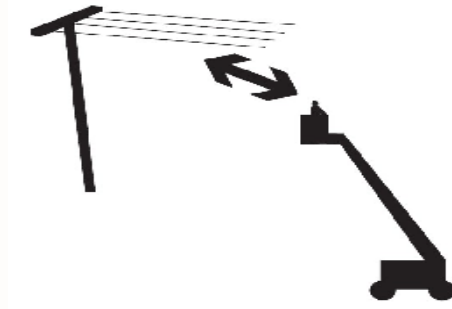

Table 1-1 Required Clearance

No.	Line Voltage	Required Clearance
1	0 to 50KV	3.05 m (10ft)
2	50 to 200KV	4.60 m (15ft1in)
3	200 to 350KV	6.10 m (20ft)
4	350 to 500KV	7.62 m (25ft)
5	500 to 750KV	10.67m (35ft)
6	750 to 1000KV	13.72m(45ft)

- b) Allow for platform movement, electrical line sway or sag, and beware of strong or gusty winds.
- c) Keep away from the machine if it contacts energized power lines. Personnel on the ground or in the platform must not touch or operate the machine until energized power lines are shut off.



Do not operate the machine during lightning or storms.

Do not use the machine as a ground for welding.

⚠ DANGER

Tip-over hazard

Occupants, equipment and materials shall not exceed the maximum platform capacity.

Table 1-2 Rated Load

Maximum platform capacity Rated Load (unrestricted)	Maximum occupants	Maximum platform capacity Rated Load (restricted)	Maximum occupants
300 kg (660lb)	2	454 kg (1000lb)	3

- a) Do not exceed the maximum platform capacity.
- b) Do not attach a platform rated at 300 kg/660lb (unrestricted range of motion) or 454 kg/1000lb (restricted range of motion) to machines with any other rated load. See the serial label NO.35 for the maximum rated load.
- c) The weight in options and accessories (such as pipe, panel bracket and welder) will reduce rated platform capacity and must be factored into total platform load. See the decals with the options and accessories.
- d) If using accessories, read, understand and obey the decals and instructions with the accessory.
- e) Do not raise or extend the boom unless the machine is on a firm, level surface. Do not raise the platform or drive the machine with boom elevated when the machine is on a slope or uneven or soft ground.

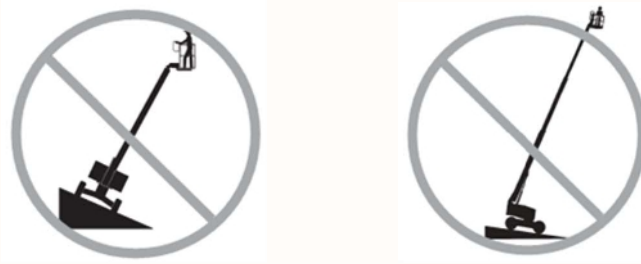

Do not use the tilt alarm as a level indicator. The tilt alarm sounds in the platform only when the machine is on a severe slope.

If the tilt alarm sounds when the platform is raised, use extreme caution. Identify the condition of the boom on the slope as shown below. Follow the steps to lower the boom before moving to a firm, level surface. Do not rotate the boom while lowering.

a) If the tilt alarm sounds with the platform uphill:

- 1) Lower the main boom.
- 2) Retract the main boom.



b) If the tilt alarm sounds with the platform downhill:

- 1) Retract the main boom.
- 2) Lower the main boom.

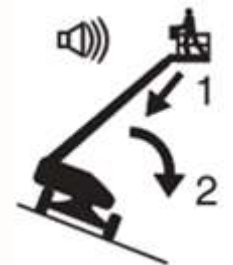

Do not raise the boom when wind speeds may exceed 12.5 m/s(28mph).

If wind speeds exceed 12.5 m/s(28mph) when the boom is raised, lower the boom and do not continue to operate the machine. Do not operate the machine in strong or gusty winds. Do not increase the surface area of the platform or the load. Increasing the area exposed to the wind will decrease machine stability.



Table 1-3 Beaufort scale

Beaufort scale	Wind speed (m/s)	Wind speed (mph)	Instruction
0	0.0-0.2	0.0-0.45	Calm
1	0.3-1.5	0.67-3.36	Light air
2	1.6-3.3	3.58-7.38	Light breeze
3	3.4-5.4	7.61-12.08	Gentle breeze
4	5.5-7.9	12.3-17.67	Moderate breeze
5	8.0-10.7	17.9-23.94	Fresh breeze
6	10.8-13.8	24.16-30.87	Strong breeze
7	13.9-17.1	31.09-38.25	Moderate gale
8	17.2-20.7	38.48-46.3	Fresh gale
9	20.8-24.4	46.53-54.58	Strong gale



- a) Be extreme careful and keep slow speeds while driving the machine in the stowed position across uneven terrain, debris, soft or slippery surfaces and nearholes and drop-offs.
- b) Do not drive the machine on or near uneven terrain, unstable surfaces or other hazardous conditions with the boom raised or extended.
- c) Never attempt to use the machine as a crane.
- d) Do not push the machine or other objects with the boom.
- e) Do not hang up structural parts on the boom.
- f) Do not tie the boom or platform to adjacent structures.
- g) Do not place loads outside the platform perimeter.
- h) Do not alter or disable machine components that in any way affect safety and stability.
- i) Do not replace items critical to machine stability with items of different weight or specification.
- j) Do not replace factory-installed tires with tires of different specification or ply rating.

- k) Do not use air-filled tires. These machines are equipped with foam-filled tires. Wheel weight is critical to stability.
- l) Do not use the platform controls to free a platform that is caught, snagged, or otherwise prevented from normal motion by an adjacent structure. All personnel must be removed from the platform before attempting to free the platform using the ground controls.
- m) Do not modify or alter an aerial work platform without prior written permission from the manufacture. Mounting attachments for holding tools or other materials onto the platform, toe boards, or guard rail system can increase the weight in the platform and the surface area of the platform or the load.
- n) Do not push off or pull toward any object outside of the platform.



⚠ DANGER

Tip-over hazard

Manual force cannot be greater than specification when operating, otherwise may cause tipping over.

Table 1-4 Maximum allowable manual force

Model	Manual force	Maximum occupants
ZT68J	400 N /90lbs force	3

- a) Do not place or attach fixed or overhanging loads to any part of this machine.
- b) Do not place ladders or scaffolds in the platform or against any part of this machine.



- c) Do not transport tools and materials unless they are evenly distributed and can be safely handled by person(s) in the platform.
- d) Do not use the machine on a moving or mobile surface or vehicle.
- e) Be sure the tires are in good condition and the lug nuts tightened, besides the tightening torque should be 310N/m (241ft lbs) .
- f) Do not drive the machine on a slope that exceeds the maximum uphill, downhill or side slope rating of the machine. Slope rating applies only to machines in the stowed position.

Table 1-5 Maximum slope rating, stowed position

Maximum slope rating, stowed position	
Platform downhill	45% (24°)
Platform uphill	30% (17°)
Side slope	17% (10°)

Note: slope rating is subject to ground conditions with one person in the platform and adequate traction. Additional platform weight may reduce slope rating.



Fall hazards

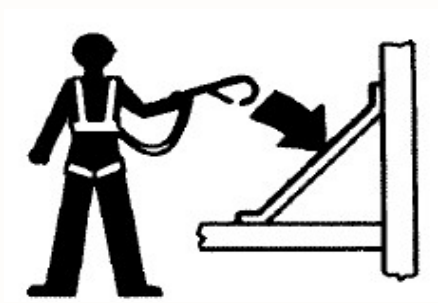

- a) Occupants must wear a safety belt or harness in accordance with governmental regulations. Attach the lanyard to the anchor provided in the platform.

SAFETY PRECAUTIONS



- b) Do not sit, stand or climb on the platform guard rails. Maintain a firm footing on the platform floor at all times.



- c) Do not climb down from the platform when raised.
- d) Keep the platform floor clear of debris. Be extremely careful while entering or exiting the platform. Do not enter or exit the platform unless the machine is in the stowed position. Enter or exit the platform through the gate only. Face the machine and ensure 'three-point contact' with the machine (two hands and one foot, or two feet and one hand) while entering or exiting the platform.

⚠ DANGER

Collision hazard

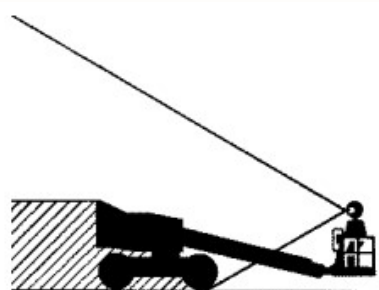

- a) Be aware of limited sight distance and blind spots when driving and operating.



- b) Check the work area for overhead obstructions or other possible hazards.



- c) Be aware of crushing hazards when grasping the platform guard rail.
- d) Be aware of the boom position and tail swing when rotating the turntable.
- e) Operators must comply with employer, job site, and governmental rules regarding use of personal protective equipment.

⚠ DANGER



Do not lower the boom unless the area below is clear of personnel and obstructions.



Limit travel speed according to the condition of the ground surface, congestion, slope, location of personnel, and any other factors which may cause collision.

Observe and use the color-coded direction arrows on the platform controls and drive chassis for drive and steer functions.

Do not operate the machine within the work range of any crane unless the controls of the crane have been locked out and/or precautions have been taken to prevent any potential collision.

No stunt driving or horseplay while operating a machine.



Body injury hazard

- a) Do not lower the boom unless the area below is clear of personnel and obstructions.
- b) Do not operate a machine with a hydraulic oil or air leak. An air leak or hydraulic leak can penetrate and/or burn skin.
- c) Improper service with components under hood will cause serious injury. Only trained maintenance personnel should access compartments.

Suggestion: access by the operator is only advised when performing a pre-operation inspection. All covers must remain closed and secured during operation.



Explosion and fire hazards

- a) Do not start the engine in hazardous locations where potentially flammable or explosive gases or particles such as liquefied petroleum gas (LPG), gasoline, or diesel may be present.
- b) Do not refuel the machine when engine is running.
- c) Refuel the machine or charge the battery only when the machine locates in an open and ventilated locations where potentially flammable or explosive gases or particles do not present.
- d) Do not operate the machine in hazardous locations where potentially flammable or explosive gases or particles may be present.

⚠ DANGER**Damaged machine hazard**

- a) Do not use a damaged or malfunctioning machine. Conduct a thorough pre-operation inspection of the machine and test all functions before each work shift.
- b) Immediately tag and remove from service a damaged or malfunctioning machine.
- c) Be sure all maintenance has been performed as specified in this manual and the appropriate Zoomlion service manual.
- d) Be sure all decals are in place and legible.
- e) Be sure operational and maintenance manuals are complete, legible, and in the storage container located on the machine.

⚠ DANGER**Component damaged hazard**

- a) Do not charge the battery with a charger greater than 12V.
- b) Do not use the machine as a ground for welding.
- c) Do not charger with unmatched power.
- d) Do not use the machine where there may be a strong magnetic field.

Battery Safety**⚠ DANGER****Burn hazard**

- a) Batteries contain acid. Always wear protective clothing and eye wear when working with batteries.



- b) Avoid spilling or contacting battery acid. Neutralize battery acid spills with baking soda and water.
- c) Do not expose the battery or charger in water or rain while charging.

⚠ DANGER**Explosion hazard**

- a) Keep sparks, flames, and lighted tobacco away from batteries. Batteries emit explosive gas.



- b) Do not use tools which could produce flames to contact battery terminals or cable clamp.

⚠ DANGER

Electrocution hazard

- a) Conduct daily check with wires and cables.
- b) Change damaged items prior to operation. Avoid contact with battery terminals.
Remove all rings, watches or other jewelry.



ZOOMLION

Operation and Safety Manual

**Section 2 Machine Components
and Controls**

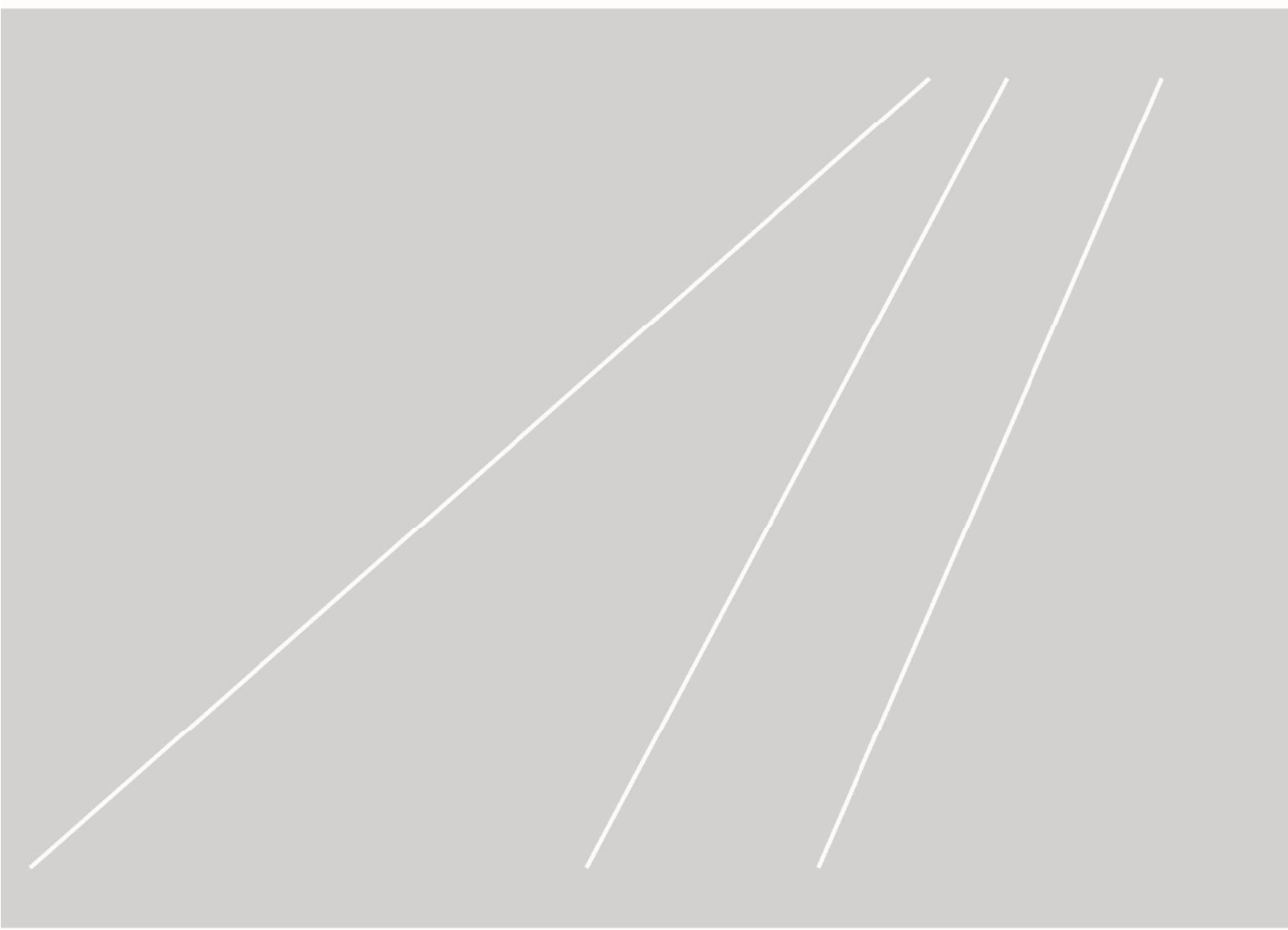

SECTION 2 MACHINE COMPONENTS AND CONTROLS

2.1 Machine Components

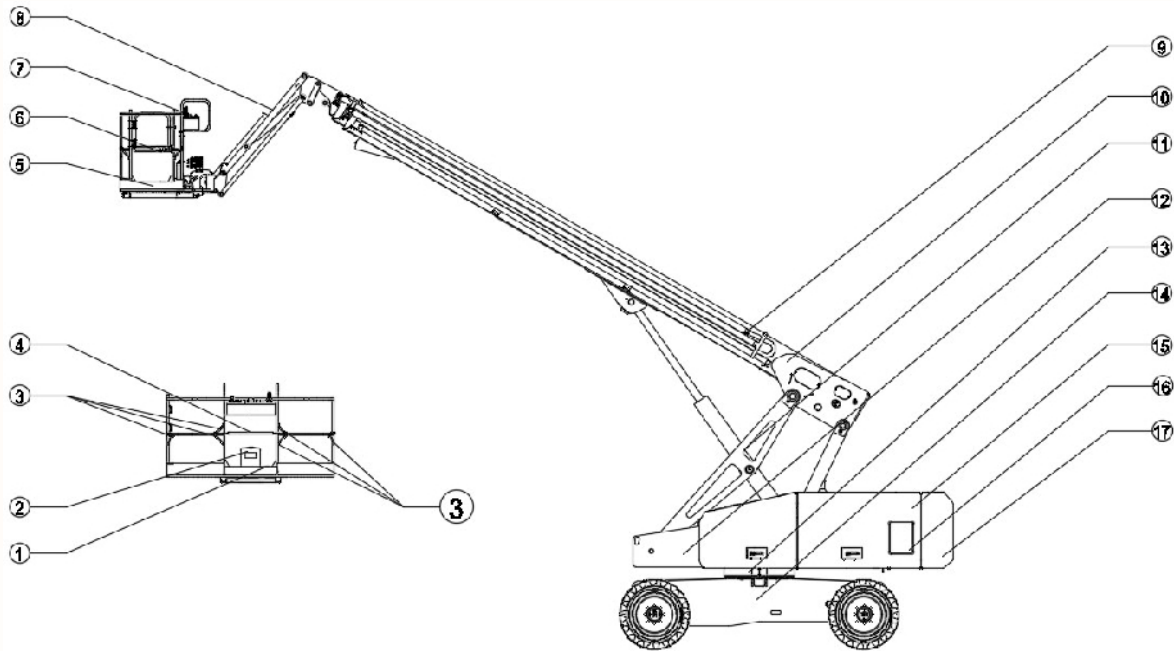

Figure 2-1 Components

Table 2-1 Component Instruction

No.	Item	No.	Item
1	Footswitch	10	Boom assembly
2	Manual storage container	11	Linkage
3	Lanyard anchorage points	12	Turntable assembly
4	Sliding rail	13	Slew mechanism
5	Work platform	14	Chassis assembly
6	Swing Gate	15	Hood assembly
7	Platform console	16	Ground control console
8	Jib	17	Counterweight
9	Cable chain		

2.2 Machine Controls and Indicators

⚠ CAUTION

The manufacturer has no direct control over machine application and operation. The user and operator or are responsible for conforming with good safety practices.

2.2.1 Ground control console

⚠ WARNING

- a) Boom lift, boom extend/retract, turntable swing, Jib lift, platform leveling, platform rotating device and auxiliary control device both equip with spring so that they will back to neutral when releasing.
- b) To avoid serious injury, do not operate machine if any control levers or toggle switches controlling platform movement do not return to the off position when released.
- c) Ensure there is no personnel under or surrounding the platform.

⚠ CAUTION

Note: Function Enable switch must be held down in order to operate main boom lift/telescope, turntable swing, jib lift, platform leveling, and Platform rotate functions.

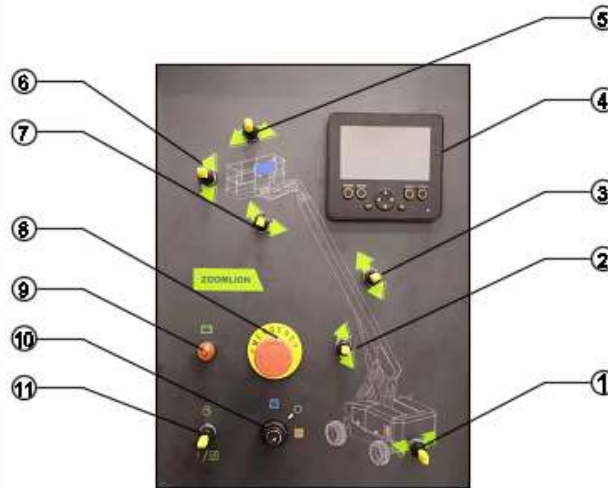

Figure 2-2 Ground Control Panel

Table 2-2 Ground Control Panel Instruction

No.	Item
1	Turntable slew switch
2	Main boom lift switch
3	Main boom telescope switch
4	Display
5	Platform rotate switch
6	Platform leveling switch
7	Jib lift switch
8	Power/Emergency stop switch
9	Charging indicator
10	Three position control switch
11	Engine start/Auxiliary power/Function enable switch

1) Turntable slew switch

Provide 360° continuous rotating.



2) Main boom lift switch

Provides raising and lowering of the main boom.

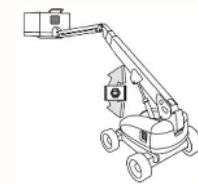

3) Main boom telescope switch

Provide extension and retraction of the main boom.



4) Display

Reveal machine working condition, fault info, and machine info.



5) Platform rotate switch

Provide platform rotate controls.



Only use the platform leveling override function for slight leveling of the platform when platform is lowered. Incorrect use could cause the load/occupants to shift or fail. Failure to do so could result in death or serious injury.

1) Platform leveling switch

Provide platform leveling controls.

This switch is used to adjust platform level in situations.

2) Jib lift switch (if equipped)

Provide raising and lowering of the jib.

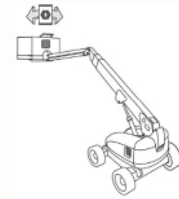

When the machine is shut down, the power/emergency stop switch must be positioned to the Off position to prevent draining the batteries.

1) Power/Emergency stop switch

Push in the red Power/Emergency Stop button to the off position to shut Platform/Ground power. Pull out the red Power/Emergency Stop button to the on position to power-up Platform/Ground Select Switch.



2) Charging indicator

Display battery charging condition. If the indicator lights up when the engine is not running, the battery is consuming power.

If the indicator goes out when the engine is started, the battery is charging.



3) Platform/Ground Select Switch

Position the three key control switch to 'Platform' (blue), platform mode works only. Position the three key control switch to 'Ground' (red), ground mode works only. The three position, key operated switch positions to middle, platform mode and ground mode shut off at the same time.



4) Engine start/Auxiliary power/Function enable switch

When pushed forward, the switch energizes the starter motor to start the engine.

To use auxiliary power, shut off engine and push the switch backward to start auxiliary pump. The function of the auxiliary pump is to provide sufficient oil flow to power-up the basic functions in the event of a main pump or engine failure.

When the engine is running, the switch must be held 'down' to enable all motion controls.

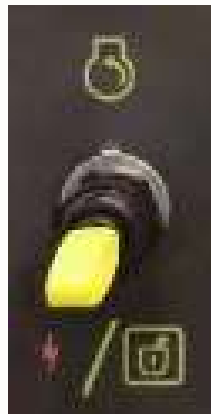

⚠ CAUTION

To use auxiliary power, operate a single action only. (Compound operation is beyond the capability of auxiliary pump motor).

2.2.2 Ground Control Indicator Panel

The interface of display is as shown below:

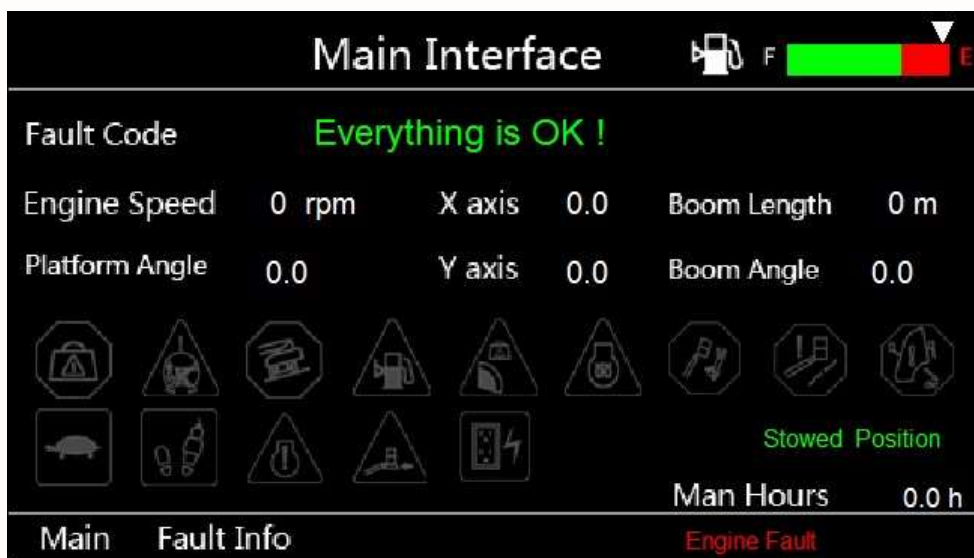

Figure 2-3

The function classification is as shown below:



Figure 2-4

No.1 indicates title; No.2 indicates fault code; No.3 indicates dynamic parameter monitor; No.4 indicates status indicator, stowed position and work station; No.5 indicates navigation bar.

- 1) When the telescopic boom lift is in stowed position with no fault code and engine failure, the interface is as shown below:

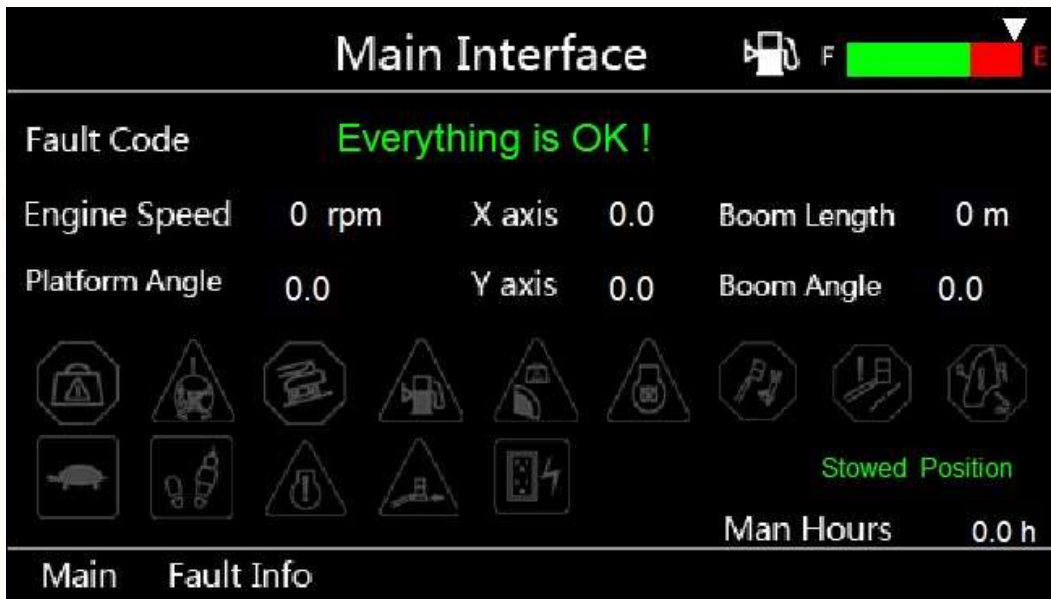

Figure 2-5

- 2) When the telescopic boom lift is in work position with no fault code and engine failure, the interface is as shown below:

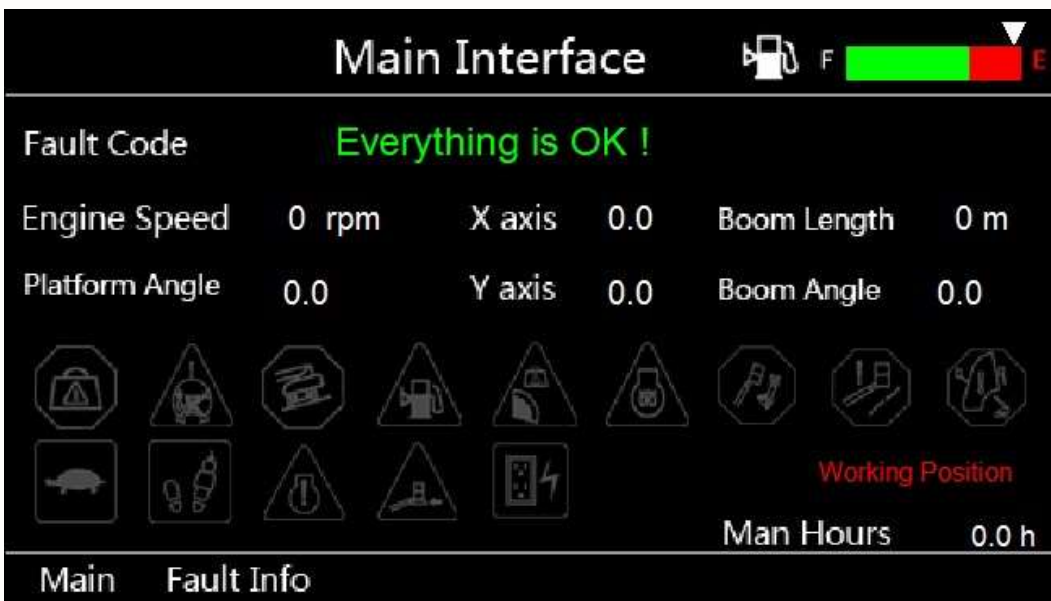

Figure 2-6

- 3) When the telescopic boom lift is in stowed position with engine failure, but no fault code reveals, the interface is as shown below, and the engine failure icon blinks in real time:

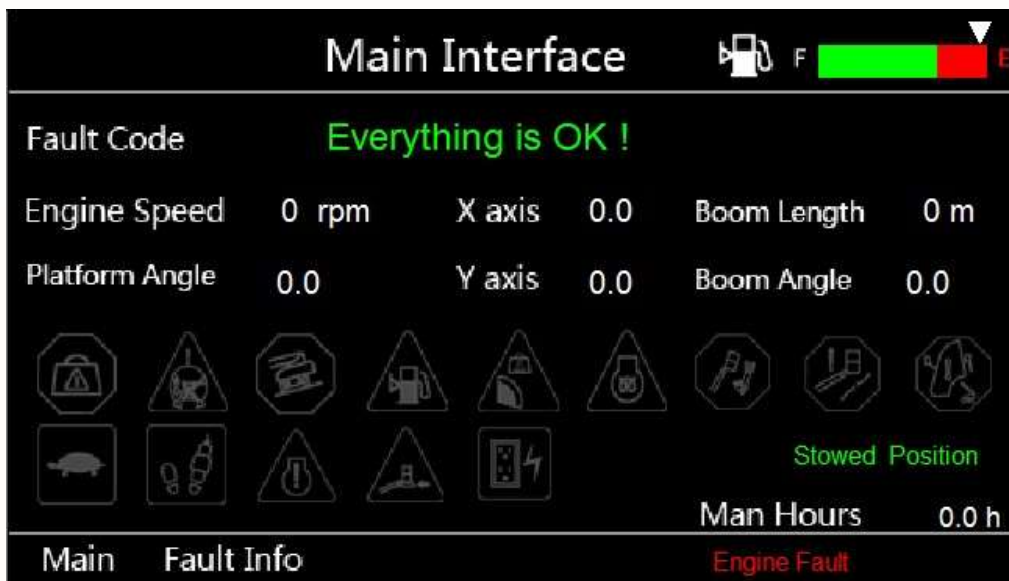

Figure 2-7

In this case, press the engine fault button to enter the engine fault page. The engine's fault code can be viewed in real time to facilitate troubleshooting. The interface of display is as shown below: after the engine troubleshooting, the engine fault on the navigation bar of the main interface disappears, and the indicator stops flashing.



Figure 2-8

Click 'Main Interface' on the navigation bar to return to the interface shown in Figure 2-7.

- When the system alarm occurs, the fault code and its description are displayed in a scrolling manner as shown below:

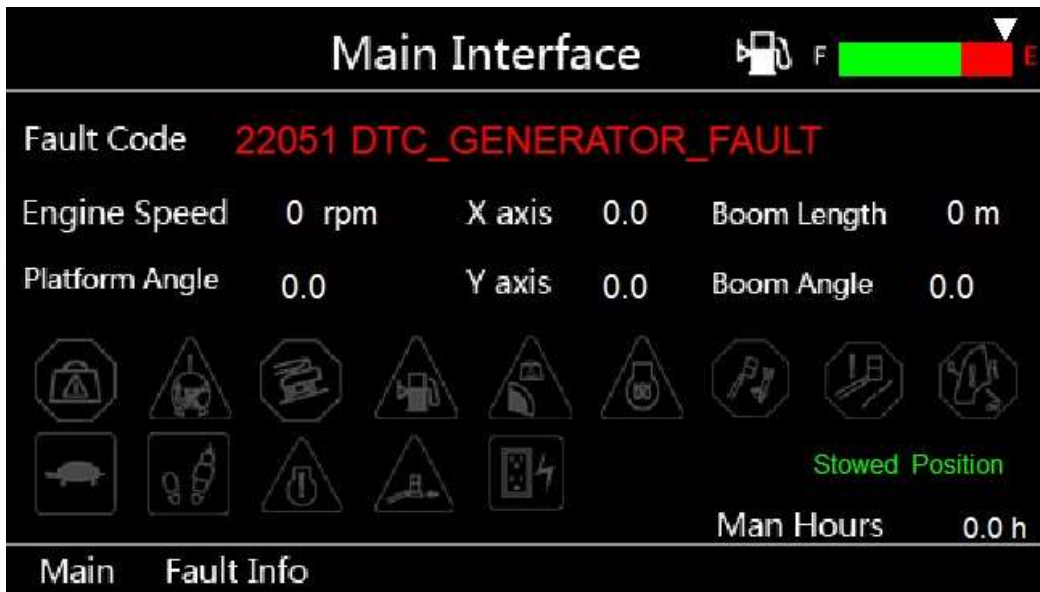

Figure 2-9

22051 indicates fault code, and DTC_GENERATOR_FAULT indicates fault description. When a system failure occurs, the 'Fault Description' button in the navigation bar is activated. Click the button to enter the fault description page and view the fault list in detail, as shown in the following figure:

The screenshot shows the 'Fault Info' page with a table containing the following data:

NO.	Status	Fault Code	Fault Description
1	○	22051	DTC GENERTOR FAULT

At the bottom, there is a navigation bar with 'Main' and 'Fault Info' buttons. The 'Fault Info' button is highlighted in white, and there are two yellow warning triangles to its right.

Figure 2-10

When certain states occur, the status indicator lights up and flashes; When the specific state is released, the turntable indicator light returns to gray, as shown in the following figure:

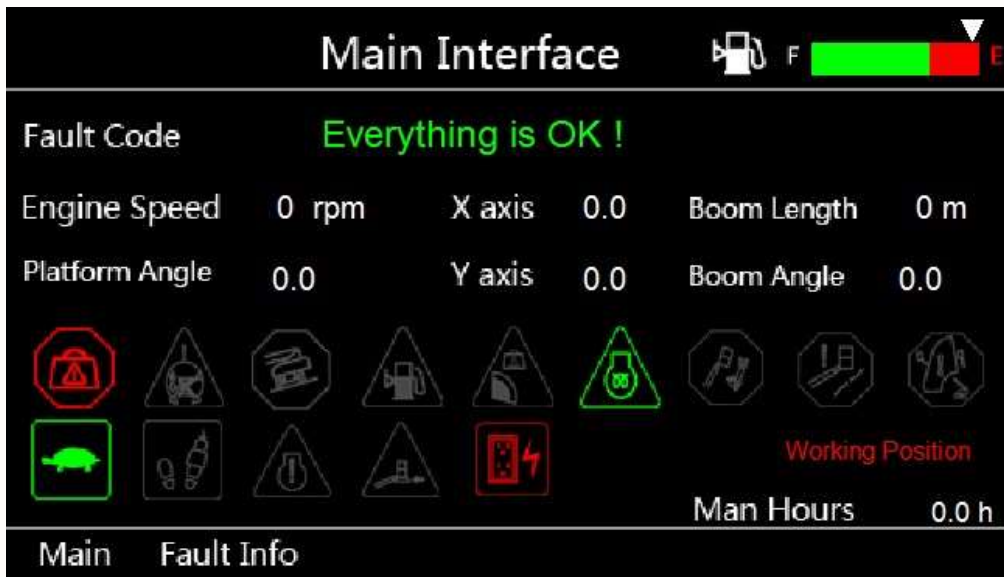

Figure 2-11

2.2.3 Platform control console

⚠ WARNING

Avoid serious injury. Do not operate machine if any control levers or toggle switches controlling platform movement do not return to the off or neutral position when released.



Figure 2-12 Platform Control Panel (Only the switch number corresponding to the existing function is identified).

Table 2-3 Platform Control Panel Instruction

No.	Item
1	Engine start/Auxiliary power switch
2	Drive direction confirm switch
3	Horn switch
4	Drive select switch
5	Power/Emergency stop switch
6	Platform leveling switch
7	Main Lift/Swing Controller
8	Function speed control
9	Work light switch
10	Platform rotate switch
11	Jib lift switch
12	Main boom telescope switch
13	Drive/Steer controller

a) Engine start/Auxiliary power switch

When pushed forward, the switch energizes the starter motor to start the engine.

To use auxiliary power, shut off engine and push the switch backward to start auxiliary pump. The function of the auxiliary pump is to provide sufficient oil flow to power-up the basic functions in the event of a main pump or engine failure.



b) Drive direction confirm switch

When the boom is swung over the rear tires or further in either direction, the Drive Orientation indicator will illuminate when the drive function is selected. Push and release the switch, and within 3 seconds move the Drive/Steer control to activate drive and steer. Before driving, locate the blue/yellow orientation arrows on both the chassis and the platform controls. Move the drive controls in a direction matching the directional arrows.

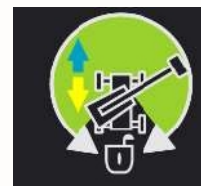

c) Horn switch

Press horn switch, the horn sounds.



⚠ WARNING

Avoid serious injury, do not operate machine. If any control levers or toggle switches controlling platform movement do not return to the off or neutral position when released.

d) Drive select switch

The forward position gives maximum drive speed.

The back position gives maximum torque for rough terrain and climbing grades.

The center position allows the machine to be driven in turtle speed.

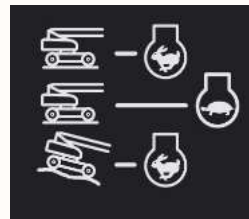

e) Power/Emergency stop switch

Push in the red Power/Emergency Stop button to the off position to shut Platform power. Pull out the red Power/Emergency Stop button to the on position to power-up Platform.



⚠ WARNING

Only use the platform leveling function for slight leveling of the platform. Incorrect use could cause the load/occupants to shift or fall. Failure to do so could result in serious injury.

f) Platform leveling switch

Provide platform leveling controls. This switch is use to adjust platform level in situations.

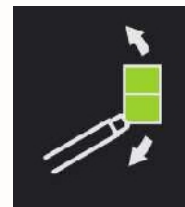

g) Main boom lift/Turntable swing controller

Provides main boom lift and platform swing.

Push forward to lift the main boom, and pull backward to lower the main boom.

Move the handle to the left to swing clockwise, and move right to swing counterclockwise.

Note: depress the foot switch before lifting the main boom and swinging the turntable, then move the control handle. The handle is equipped with gas spring that the handle could return to neutral (off) position automatically when released.

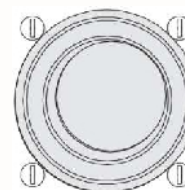

h) Function speed control

This control could adjust the main boom telescoping speed.

Control the driving, turntable swinging and main boom lifting speed by function speed control to switch the speed between turtle and rabbit modes.

Turning the knob all the way counterclockwise until it clicks to put drive, main boom lift and swing into creep mode.

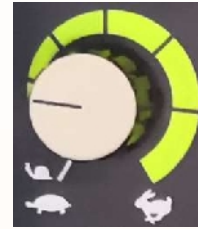

i) work light switch (if equipped)

This switch operates the chassis lights if machine is so equipped.



j) Platform rotate switch

Provide platform rotate controls.



k) Jib lift switch

Provide raising and lowering of the jib.



l) Main boom telescope switch

Provide extension and retraction of the main boom.



m) Drive/Steer controller

Provides drive/steer controls.

Push forward to drive forward, and pull backward to drive backward;

Steering is accomplished via a thumb-activated rocker switch on the end of the steer handle.



2.2.4 Platform control indicator panel

Note: the indicator lights will illuminate for approximately 1 second when the key is positioned to the on position to act as a self test.

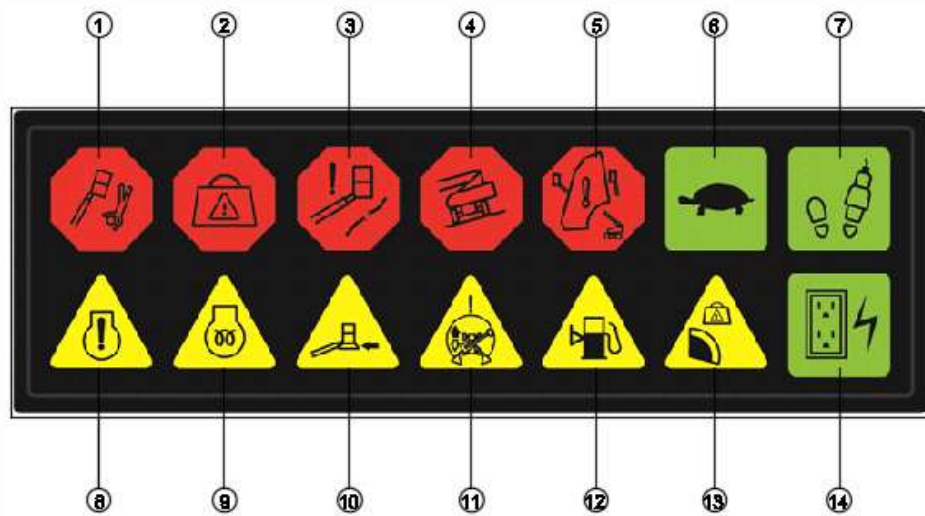

Figure 2-13 Platform Control Indicator Panel

Table 2-4 Platform Indicator Panel Instruction

No.	Item
1	Leveling system fault indicator
2	Platform overload indicator
3	Wire rope loosen indicator
4	Tilt Alarm Warning Light
5	Main boom system fault indicator
6	Creep Speed Indicator
7	Footswitch indicator
8	System fault indicator
9	Glow plug indicator
10	Soft touch indicator
11	Drive direction confirm indicator
12	Low fuel indicator
13	Limited position indicator
14	AC Generator

⚠ WARNING

If leveling system fault indicator lights up, shut off the machine and restart. If fault occurs again, retract the platform to stowed position via manual leveling function, and service the leveling system.

1) Leveling system fault indicator

Indicates faults in electronic leveling system. Indicator will flash, and alarm will sound. If boom is lifting, creep mode is automatically activated. If leveling system fault indicator lights up, shut off the machine and restart. If fault occurs again, retract the platform to stowed position via manual leveling function, and service the leveling system.



2) Platform overload indicator

Indicates the platform has been overloaded.



3) Wire rope loosen indicator

Indicates loosen or damage of main boom wire rope, service or adjust it immediately.



4) Tilt Alarm Warning Light

This illuminator indicates that the chassis is on a slope.

An alarm will also sound when the chassis is on an excessive slope (over 3°).

If tilt alarm sounds in stowed position, creep mode is automatically activated.

If tilt alarm sounds, drive, steer and telescope functions will be disabled, and other motions will be limited to creep mode.



⚠ WARNING

a) If the tilt alarm sounds with the platform uphill, proceed as follows:

1. Lower the main boom.
2. Retract the main boom.



b) If the tilt alarm sounds with the platform downhill, proceed as follows:

1. Retract the main boom.
2. Lower the main boom.



- c) Main boom system fault indicator;

Indicates that the length of main boom cannot measure, need check boom length sensor.



- d) Creep mode indicator

When the Function Speed Control is turned to the creep position, the indicator acts as a reminder that all functions are set to slowest speed. The light will be on continuously if the operator selects creep speed.



- e) Footswitch indicator

To operate any function, the footswitch must be depressed and the function selected within 7 seconds.

The enable indicator shows that the controls are enabled.



If a function is not selected within seven seconds, or if a seven second lapse between ending on function and beginning the next function, the enable light will go out and the foot switch must be released and depressed again to enable the controls. Releasing the foot switch stops all platform controls.

WARNING

To avoid serious injury, do not remove, modify or disable the foot switch by blocking or any other means. Foot switch must be adjusted if malfunctions occur.

- 1) System fault indicator

Indicates system faults.



- 2) Glow plug indicator

Indicates the glow plugs are operating.

Start engine until glow plug light goes out.



- 3) Soft touch indicator

Indicate that soft touch function activates.



4) Drive direction confirm indicator

When the boom is swung over the rear tires or further in either direction, the Drive Orientation indicator will illuminate when the drive function is selected.



This is a signal for the operator to verify that the drive control is being operated in the proper direction (to verify if the machine drive in reversed direction).

5) Low fuel indicator

Indicates a low fuel condition in the tank.



6) Limited position indicator

Indicate limited position of boom.



7) AC generator indicator

Indicate the generator is in operation.



ZOOMLION

Operation and Safety Manual

Section 3 Machine Inspection

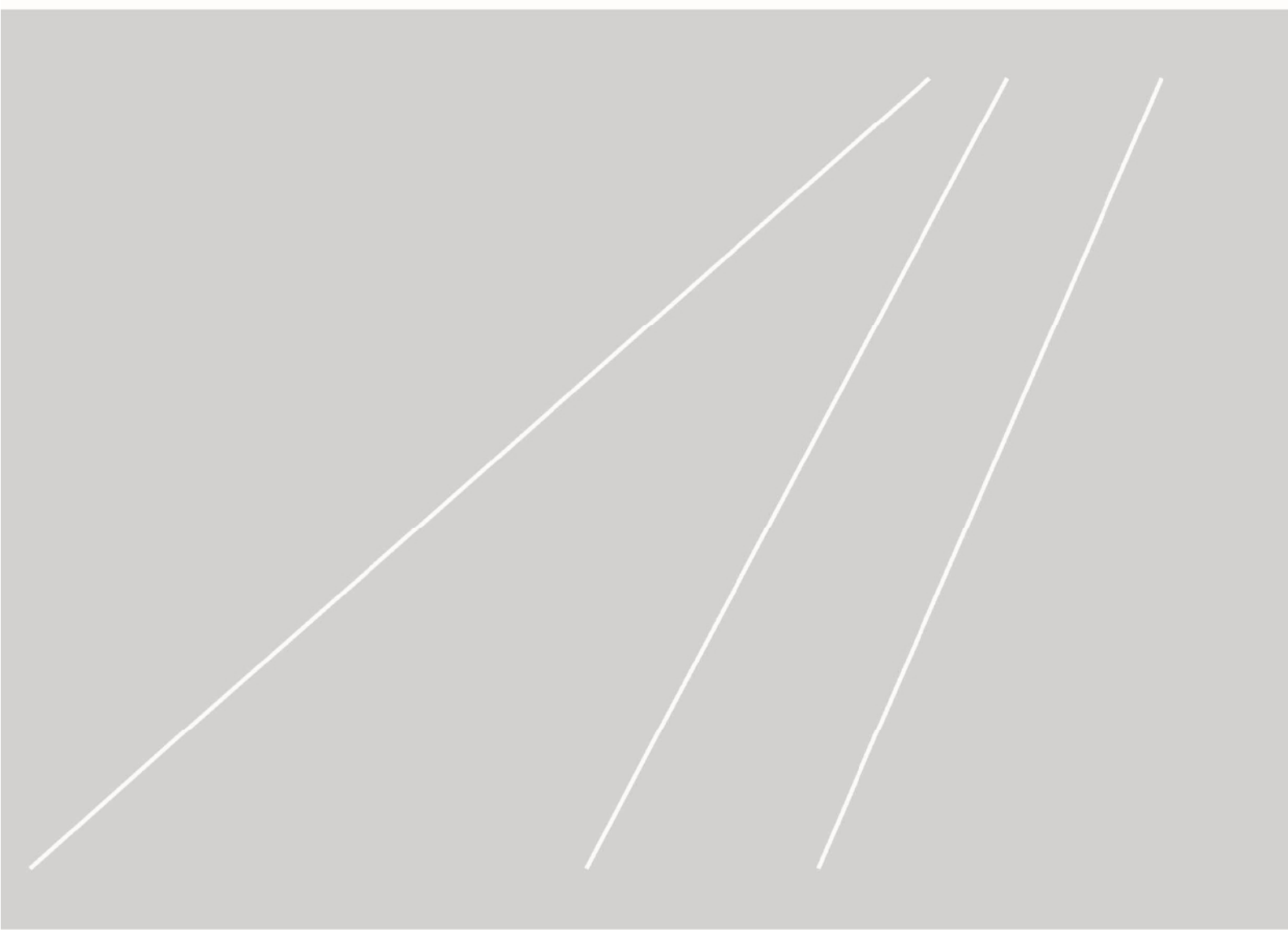

SECTION 3 MACHINE INSPECTION

3.1 General



An operator must not operate the machine, only if:

He has learned and practiced the principles of safe machine operation contained in this operational manual.

- a) Only use the machine as it was intended.
- b) Know and understand the pre-operation inspection before going on to the next section.
- c) Implement functional test before operating the machine at all times.
- d) Inspect job site.
- e) Only use the machine as it was intended.

3.1.1 Pre-Start inspection principle

- a) It is the responsibility of the operator to perform a pre-operation inspection and routine maintenance.
- b) The pre-operation inspection is a visual inspection performed by the operator prior to each work shift. The inspection is designed to discover if anything is apparently wrong with a machine before the operator performs the function tests.
- c) The pre-operation inspection also serves to determine if routine maintenance procedures are required. Only routine maintenance items specified in this manual may be performed by the operator.
- d) Refer to the list on the next page and check each of the items.
- e) If damage or any unauthorized variation from factory delivered condition is discovered, the machine must be tagged and removed from service.
- f) Repairs to the machine may only be made by a qualified service technician, according to the manufacturer's specifications. After repairs are completed, the operator must perform a pre-operation inspection again before going on to the function tests.
- g) Scheduled maintenance inspections shall be performed by qualified service technicians, according to the manufacturer's specifications and the requirements listed in the responsibilities manual.

3.1.2 Pre-start inspection

- a) Be sure operator's, safety, and responsibilities manuals are complete, legible, and in the storage container located on the machine.
- b) Be sure all decals are in place and legible. See Inspections section.
- c) Check for hydraulic oil leaks and proper oil level. Add oil if needed. See Maintenance section.

- d) Check for battery fluid leaks and proper fluid level. Add oil if needed. See Maintenance section.
- e) Check for engine coolant leaks and proper level of coolant. Add coolant if needed, refer to Maintenance section.
- f) Check the following components or areas for damage, improperly installed, or missing parts and unauthorized modifications:
 - 1) Electrical components, wiring, and electrical cables.
 - 2) Hydraulic hoses, fittings, cylinders, and manifolds.
 - 3) Fuel and hydraulic tanks.
 - 4) drive gear.
 - 5) Wear pads.
 - 6) Tires and wheels.
 - 7) Engine and related components.
 - 8) Limited switch and horn.
 - 9) Alarm and indicator (if equipped).
 - 10) Nuts, bolts and other fasteners.
 - 11) Platform entry mid-rail or gate.
 - 12) Platform load cell.
 - 13) Lanyard anchorage points.
 - 14) Check entire machine for:
 - Cracks in welds or structural components.
 - Dents or damage to machine.
 - Excessive rust, corrosion or oxidation.
- g) Be sure that all structural and other critical components are present and all associated fasteners and pins are in place and properly tightened.

Be sure that engine tray is locked and check battery connection.

After you complete your inspection, be sure that all covers are in place and latched.

Note: be sure that the jib is in proper place when raising the platform for maintenance. See Operating Instruction section.

3.2 Function Test

3.2.1 Function test principle

- a) The function tests are designed to discover any malfunctions before the machine is put into service. The operator must follow the step-by-step instructions to test all machine functions.
- b) A malfunctioning machine must never be used. If malfunctions are discovered, the machine must be tagged and removed from service. Repairs to the machine may only be made by a qualified service technician, according to the manufacturer's specifications.
- c) After repairs are completed, the operator must perform a pre-operation inspection again before putting the machine into service.



An operator must not operate the machine, only if:

He has learned and practiced the principles of safe machine operation contained in this operational manual.

- a) Avoid hazardous situations.
- b) Perform a pre-operation inspection at all times.
- c) Implement functional test before operating the machine at all times.
- d) Inspect job site.
- e) Only use the machine as it was intended.

3.2.2 Ground function check

- a) Test emergency stop:
 - 1) Select a test area that is firm, level and free of obstruction.
 - 2) Turn the key switch to ground control (red).
 - 3) Pull out the red Power/Emergency Stop button to the on position.
 - 4) Check test result: ground display powers up.
 - 5) Start the engine. See Operating Instruction section.
 - 6) Push in the red Power/Emergency Stop button to the off position.
 - 7) Check test result: the engine should shut off and no functions should operate.
- b) Test machine functions:
 - 1) Start the engine at the ground controls.

Do not operate the Function Enable Button.

Attempt to activate each boom and platform function button.

Check test result: no functions should operate.

Start the engine at the ground controls.

Push and hold the Function Enable Button and maintain the enabled state.

Attempt to activate each function button.

Check test result: all functions should operate when function enable switch activated.

c) Test auxiliary power:

- 1) Shut off the engine at the ground controls.
- 2) Pull out the red Power/Emergency Stop button to the on position.
- 3) Operate auxiliary power switch.
- 4) Attempt to activate each function button.

Check test result: all boom and platform functions should operate at the auxiliary power mode.

Note: do not recommend to use auxiliary power for a long time if the engine could run normally as long time usage of auxiliary power could shorten the service life of auxiliary pump and battery.

3.2.3 Platform function check

a) Test emergency stop:

- 1) Select a test area that is firm, level and free of obstruction.
- 2) Turn the key switch to platform control (blue).
- 3) Pull out the red Power/Emergency Stop button to the on position.
- 4) Start the engine. See Operating Instruction section.
- 5) Push in the red Power/Emergency Stop button to the off position.

Check test result: the engine should shut off and no functions should operate.

b) Test the foot switch:

- 1) Pull out the red Power/Emergency Stop button to the on position.
- 2) Press down the foot switch and activate each boom and platform function button.
- 3) Attempt to start the engine.

Check test result: the engine should not start.

- 4) Pull out the red Power/Emergency Stop button to the on position.
- 5) Do not press down the foot switch.
- 6) Attempt to start the engine.

- 7) Check test result: the engine should start.
- 8) Start the engine at the platform controls.
- 9) Do not press down the foot switch.
- 10) Attempt to activate each boom and platform function button.
- Check test result: no boom and platform functions should operate.
- 11) Start the engine at the platform controls.
- 12) Press down the foot switch and activate each boom and platform function button.
- 13) Attempt to activate each function button.

Check test result: all boom and platform functions should operate when foot switch activated.

c) Test Auxiliary Power:

- 1) Shut off the engine at the platform controls.
- 2) Pull out the red Power/Emergency Stop button to the on position.
- 3) Operate auxiliary power switch.
- 4) Attempt to activate each function button.

Check test result: all boom and platform functions except driving and steering should operate at the auxiliary power mode.

d) Test Horn:

- 1) Press the horn button at the platform controls.

Check test result: the horn should sound.

e) Test the Steering

- 1) Start the engine at the platform controls.

Press down the foot switch and activate each boom and platform function button.

Move the steering handle.

Release the steering handle.

Check test result: the wheels should turn in the direction that the control handle operates. Release the steering handle, the steering function is disabled.

f) Test Drive and Braking

- 1) Start the engine at the platform controls.

Press down the foot switch and activate each boom and platform function button.

Move the drive control handle.

Release the drive control handle.

Check test result: the machine should turn in the direction that the control handle operates.

Release the drive handle, the drive function is disabled.

g) Test the Drive Enable System

1) Start the engine at the platform controls.

Press down the foot switch and activate each boom and platform function button.



Rotate the turntable until the main boom moves past a circle-end wheel.

Attempt to operate drive handle.

Check test result: the drive enable indicator light should light up while the main boom is anywhere outside of the range shown. The drive function should not operate.

Move the drive enable toggle switch.

Attempt to operate drive handle.

Check test result: move the drive enable toggle switch and drive in low speed.

h) Test Limited Drive Speed

1) Start the engine at the platform controls.

Press down the foot switch and activate each boom and platform function button.



Lift the main boom up to about 12° above horizontal.

Attempt to operate drive handle.

Check test result: the drive speed should switch to low speed with the main boom raised.

Lower the main boom to stowed position.

Extend the main boom by 1 meter/3.28ft.

Attempt to operate drive handle.

Check test result: the drive speed should switch to low speed with the main boom extended.

Lower the main boom to stowed position.

Attempt to operate drive handle.

Check test result: the drive speed should switch to high speed with the main boom retracted to stowed position.

Note: the angle between the boom and the horizontal ground is less than 12° , the extension length is less than 1 meter/3.28ft, and it is within $\pm 35^\circ$ of the center line of the vehicle.

i) Test drive tilt protection

- 1) Press down the foot switch and activate each boom and platform function button.
 - 2) Drive the machine till the angle reaches 3.5° when the main boom is fully retracted (forward to backward).
 - 3) Check test result: all actions are unrestricted, all motion speeds are limited to low speed, and the platform alarm sounds an alarm.
 - 4) Move the machine to the ground and extend the main boom approximately 1 meter/3.28ft or more.
 - 5) Drive the machine to a slope greater than 3.5° from the horizontal ground (forward to backward).
 - 6) Check test result: when the machine reaches a 3.5° chassis tilt, the machine is prohibited from walking and turning, and the platform alarm gives an alarm.
 - 7) Retract the main boom to the stowed position.
 - 8) Check test result: the machine could drive.
 - 9) Move the machine to the ground and raise the main boom to a height that is greater than 12° from the horizontal level.
 - 10) Drive the machine to a slope greater than 3.5° from the horizontal ground (forward to backward).
 - 11) Check test result: when the machine reaches a 3.5° chassis tilt, the machine is prohibited from walking and turning, and the platform alarm gives an alarm.
 - 12) Retract the main boom to the stowed position.
- Check test result: the machine could drive.

3.3 Workplace Inspection



An operator must not operate the machine, only if:

He has learned and practiced the principles of safe machine operation contained in this operational manual.

- a) Avoid hazardous situations.
- b) Perform a pre-operation inspection at all times.
- c) Implement functional test before operating the machine at all times.
- d) Inspect job site.

Know and understand the workplace inspection before going on to the next section.

Only use the machine as it was intended.

3.3.1 Workplace inspection principle

The workplace inspection helps the operator determine if the workplace is suitable for safe machine operation. It should be performed by the operator prior to moving the machine to the workplace.

It is the operator's responsibility to read and remember the workplace hazards, then watch for and avoid them while moving, setting up, and operating the machine.

3.3.2 Workplace inspection

Be aware of and avoid the following hazardous situations:

- a) Drop-offs or holes.
- b) bumps, floor obstructions, or debris.
- c) Sloped surfaces.
- d) Unstable or slippery surfaces.
- e) Overhead obstructions and high voltage conductors.
- f) Hazardous locations.
- g) Inadequate surface support to withstand all load forces imposed by the machine.
- h) Wind and weather conditions.
- i) the presence of unauthorized personnel.
- j) Other possible unsafe condition.

3.4 Decal Inspection

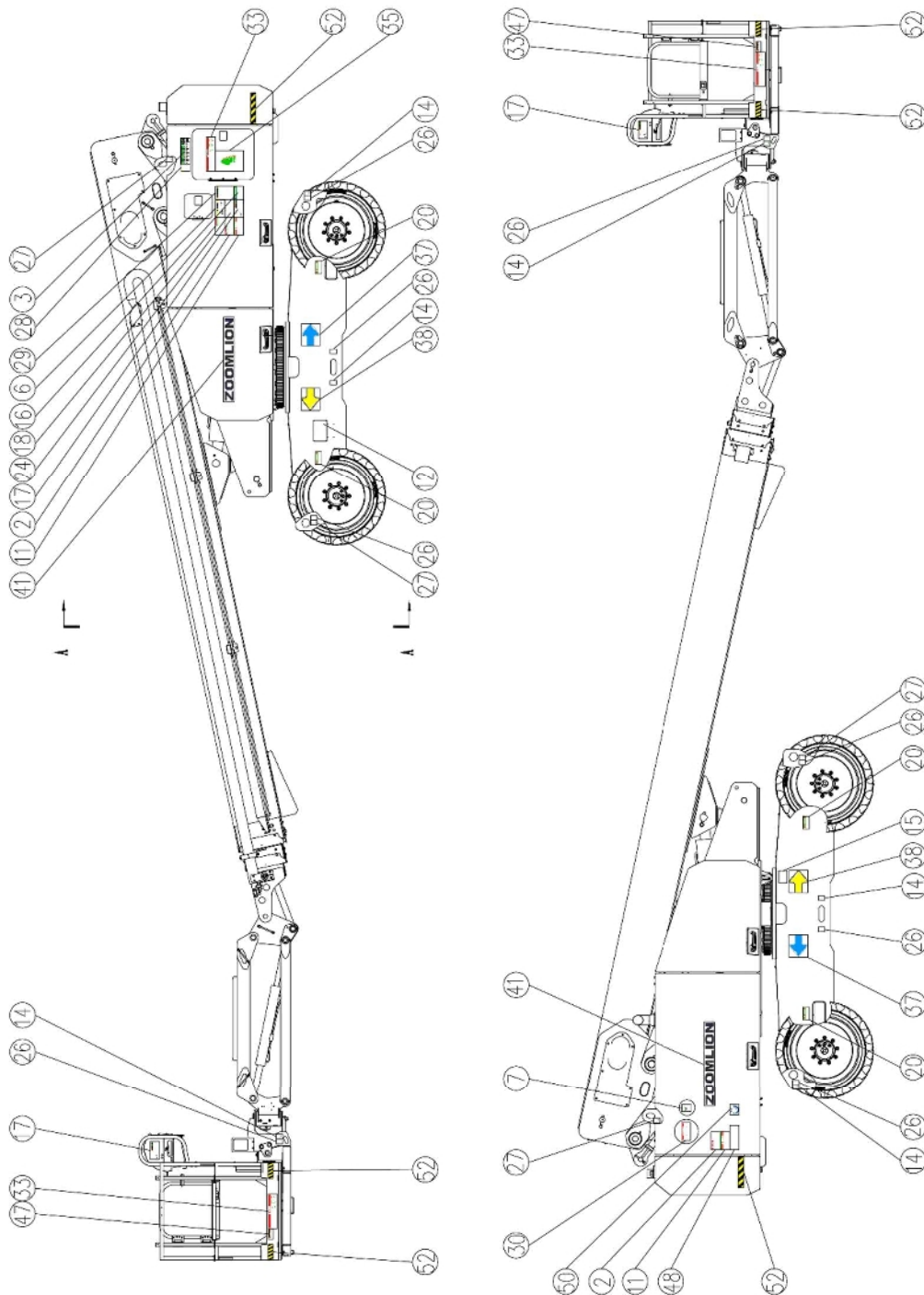

Figure 3-1 Decal Position

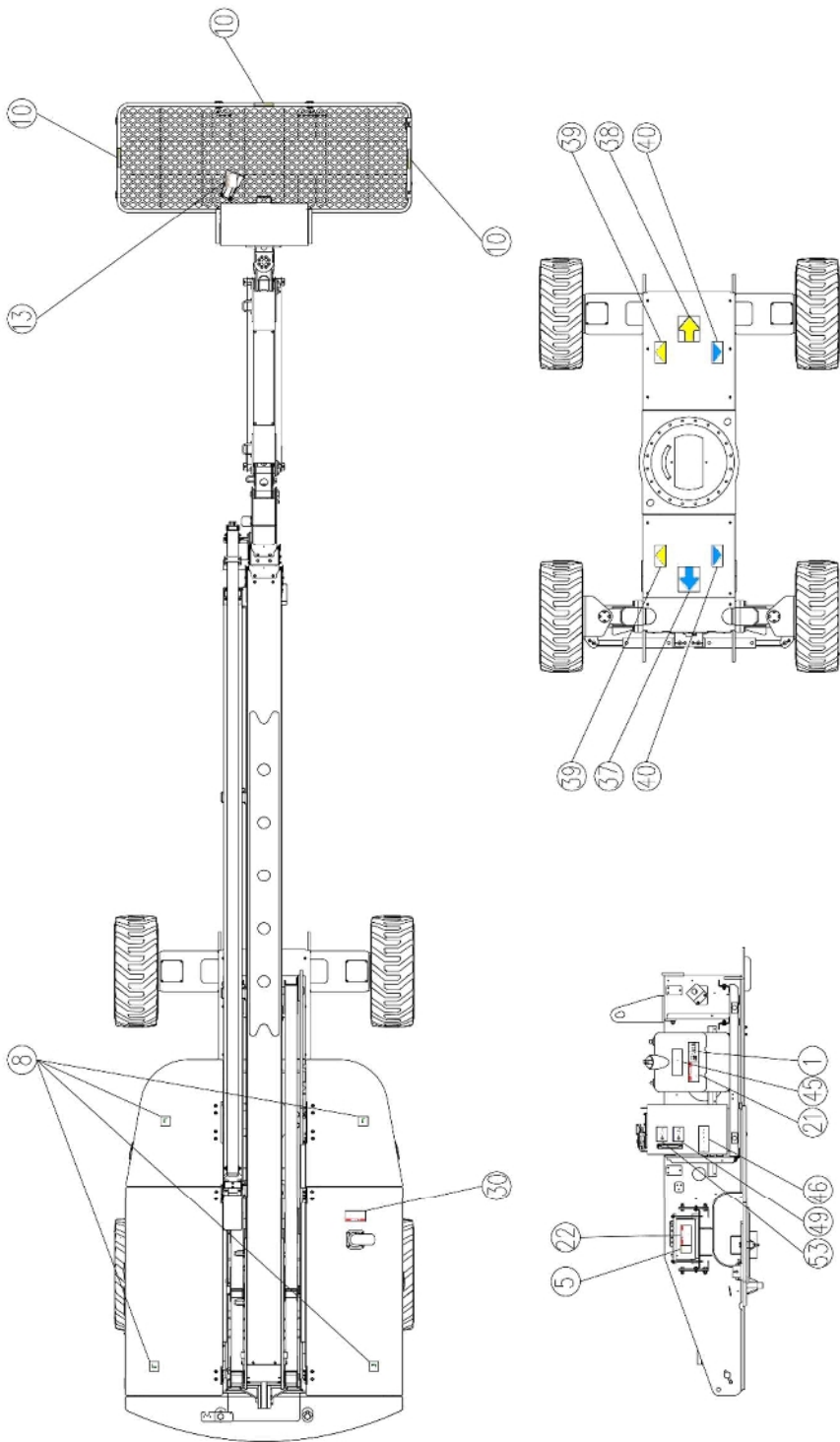

Figure 3-1 Decal Position (continuous)

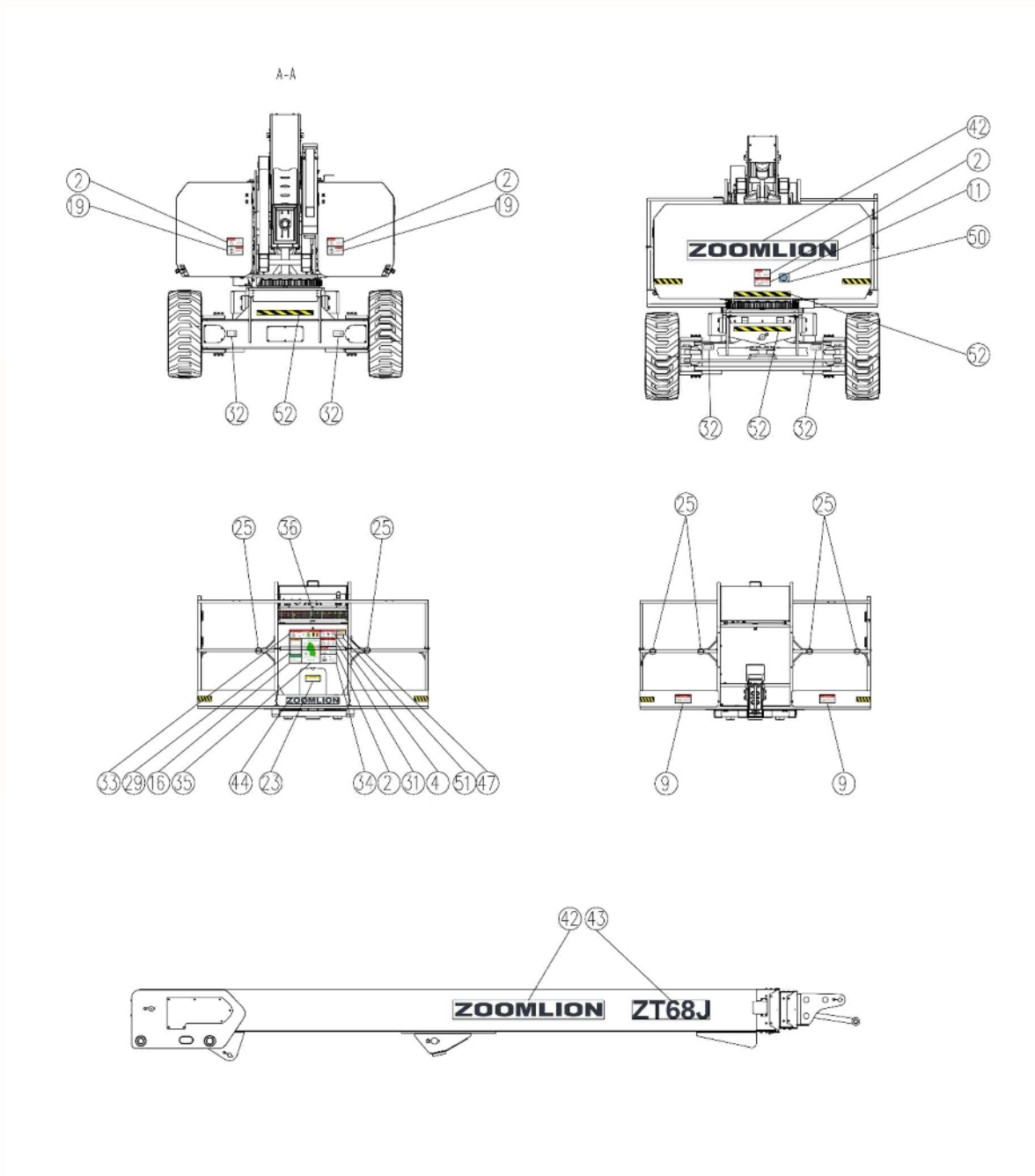

Figure 3-1 Decal Position (continued)

Use the pictures on next page to verify that all decals are legible and in place.

Below is a numerical list with quantities and descriptions.

Table 3-1 Decals

Numbers are corresponded to the decal (not all decal are pasted on the machine)





No.	Part No.	Qty	Decal
1	00773407000201060	1	
	Label- Refuel		
2	00773407001601070	6	
	Hazard- Electrocutation hazards		
3	00773407001601080	1	
	Label- Ground controls instruction		
4	00773407001601090	1	
	Hazard- Tip-over hazard I		
5	00773407000401150	1	
	Caution- Cut off battery		
6	00773407000401160	1	
	Caution- Trained and authorized personnel operate the machine only		

Table 3-1 Decals

Numbers are corresponded to the decal (not all decal are pasted on the machine)

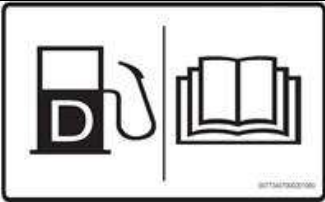
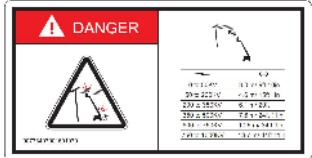
No.	Part No.	Qty	Decal
7	00773407001601170	1	
	Hazard- Prohibit contact		
8	00773407000201180	4	
	Label- Prohibit step on		
9	00773407001601190	2	
	Hazard- Crushing hazard		
10	00773407000401200	3	
	Caution- Prohibit lanyard		
11	00773407001601210	3	
	Hazard- Crushing hazard		
12	00771409901601040	1	
	ZT68J nameplate		

Table 3-1 Decals

Numbers are corresponded to the decal (not all decal are pasted on the machine)

No.	Part No.	Qty	Decal
13	00773407000401230	1	
	Warn- Foot switch malfunction		
14	00773407000201240	6	
	Label- Prohibit lifting		
15	00773407000401250	1	
	Label- Plug stop pin when transporting		
16	00773407000401260	2	
	Label- Application precautions		
17	00773407000401270	3	
	Warn- Prohibit high pressure water-beaktest		
18	00773407001601310	1	
	Hazard- Tip-over hazard II		

Table 3-1 Decals

Numbers are corresponded to the decal (not all decal are pasted on the machine)

No.	Part No.	Qty	Decal
19	00773407001601320	2	
	Warn- Crushing hazard		
20	00773407001601360	4	
	Hazard- Tip-over hazard III		
21	00773407001601370	1	
	Hazard- Explosion hazard I		
22	00773407000201380	1	
	Hazard- Explosion hazard II		
23	00773407000401390	1	
	Caution-Preserve the manual		
24	00773407000401400	1	
	Label- Read the manual		
25	00773407001601410	6	
	Label- Lanyard anchorage point		

Table 3-1 Decals

Numbers are corresponded to the decal (not all decal are pasted on the machine)





No.	Part No.	Qty	Decal
26	00773407000201420	8	 00773407000201420
	Label- Tie down		
27	00773407000201430	4	 00773407000201430
	Label- Prohibit lifting		
28	00773407000401440	1	 00773407000401440
	Caution- Main power operating instruction		
29	00773407000401450	2	 00773407000401450
	Warn- Pre-inspection		
30	00773407001601470	2	 00773407001601470
	Hazard- Burn hazards		
31	00771407001601010	1	 00771407001601010
	Hazard- Tip-over hazard IV		

Table 3-1 Decals

Numbers are corresponded to the decal (not all decal are pasted on the machine)

No.	Part No.	Qty	Decal
32	00771107001601060	4	
	Label- Wheel load		
33	00771107001601020	4	
	Hazard- Tip-over hazard V		
34	00771107000201050	1	
	Label- Slope rating		
35	00771107001601010	2	
	Label- Work envelope		
36	00771407001601070	1	
	Label- Ground controls instruction		
37	00771407000201080	3	
	Label- Blue arrow		

Table 3-1 Decals

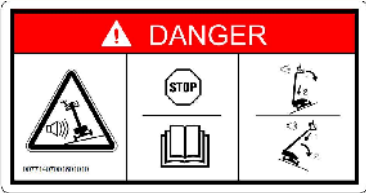
Numbers are corresponded to the decal (not all decal are pasted on the machine)



No.	Part No.	Qty	Decal
38	00771407000201090	3	
	Label- Yellow arrow		
39	00771407000201100	2	
	Label- Yellow triangle		
40	00771407000201110	2	
	Label- Blue triangle		
41	00773407000201030	2	ZOOMLION
	Label- ZOOMLION		
42	00771407000201130	2	ZOOMLION
	Label- ZOOMLION		
43	00771107001601070	1	ZT68J
	Decal- ZT68J		



Table 3-1 Decals

Numbers are corresponded to the decal (not all decal are pasted on the machine)

No.	Part No.	Qty	Decal
44	00773407000201010	1	
	Label- ZOOMLION		
45	00771407000401150	1	
	Label- Diesel tank		
46	00771407000401160	1	
	Label- Hydraulic oil tank		
47	00775607000401320	3	
	Label- Non-insulated		
48	00771107001601030	1	
	Label- Transport and lift instruction		
49	00773407000201480	1	
	Decal- Low oil level		
50	00771407001601180	2	
	US Identification		

Table 3-1 Decals

Numbers are corresponded to the decal (not all decal are pasted on the machine)

No.	Part No.	Qty	Decal
51	00771407001601190	1	
	California Bill Warns		
52	1109900961	11.9ft	
	Warning Tape		
53	00773407000201490	1	
	Decal- High oil level		

ZOOMLION

Operation and Safety Manual

Section 4 Operation Instruction

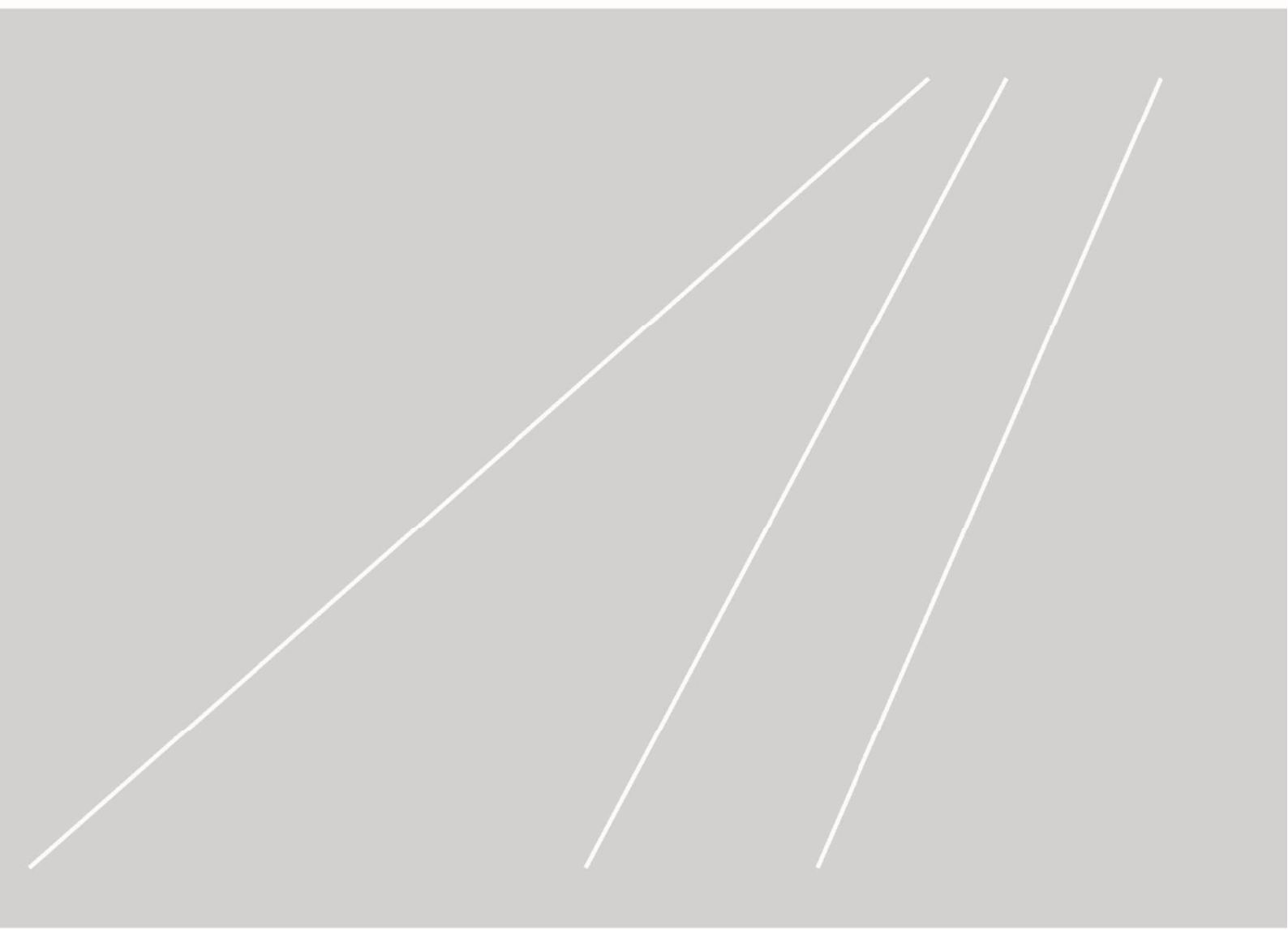

SECTION 4 OPERATION INSTRUCTION

4.1 General



An operator must not operate the machine, only if:

He has learned and practiced the principles of safe machine operation contained in this operational manual.

- a) Avoid hazardous situations.
- b) Perform a pre-operation inspection at all times.
- c) Implement functional test before operating the machine at all times.
- d) Inspect job site.
- e) Only use the machine as it was intended.

Fundamentals

The Operating Instructions section provides instructions for each aspect of machine operation. It is the operator's responsibility to follow all the safety rules and instructions in the operational, safety and responsibilities manuals.

Using the machine for anything other than lifting personnel, along with their tools and materials, to an aerial work site is unsafe and dangerous.

Only trained and authorized personnel should be permitted to operate a machine. If more than one operator is expected to use a machine at different times in the same work shift, they must all be qualified operators and are all expected to follow all safety rules and instructions in the operator's, safety and responsibilities manuals. That means every new operator should perform a pre-operation inspection, function tests, and a workplace inspection before using the machine.

4.2 Machine Operation

4.2.1 Engine operation

Note:

- a) Initial starting should always be performed from the Ground Control station.
- b) When operating a machine at high altitudes, a decrease in machine performance may occur due to a decrease in air density.
- c) When operating a machine at high ambient temperatures, a decrease in machine performance and an increase in engine coolant temperature may occur.

- d) Machines with diesel engines. After turning on ignition, operation must wait until glow plug indicator light goes out before cranking engine.
- e) Footswitch must be in released (up) position before starter will operate. If starter operates with footswitch in the depressed position, do not operate machine.
- f) If an engine malfunction causes a unscheduled shutdown, determine the cause and correct it before restarting the engine.
- g) Consult ZOOMLION customer service to know more about the operation under abnormal conditions.

4.2.1.1 Engine start



Machines with diesel engines. After turning on ignition, operation must wait until glow plug indicator light goes out before cranking engine.

- a) Turn key of SELECT switch to GROUND.



- b) Pull the Power/Emergency Stop switch to ON.



- c) Push the Engine Start switch until engine starts.



- d) After engine has had sufficient time to warm up, push in the power/Emergency Stop switch and shut engine off.



- e) Turn Platform/Ground Select switch to Ground.

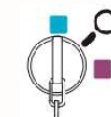

- f) From Platform position POWER/EMERGENCY STOP switch to ON.



- g) Push the ENGINE START switch to the forward position until engine starts.



CAUTION

Allow engine to warm-up for a few minutes at low speed before applying any load.

If engine fails to start promptly, do not crank for an extended period. Should engine fail to start once again, allow starter to ‘cool off’ for 2-3 minutes. If engine fails after several attempts, refer to engine maintenance manual.

4.2.1.2 Engine shut down

- a) Remove all load and allow engine to operate at low speed for 3-5 minutes to reduce the internal temperature of the engine.



- b) Push Power/Emergency Stop switch.



- c) Turn Platform/Ground Select switch to Off.

Refer to Engine Manufacturer's manual for detailed information.

4.2.2 Drive operation

Traveling is limited by two factors:

- a) Gradeability, which is the percent of grade of the incline the machine can climb.
- b) Side slope, which is angle of the slope the machine can be driven across.



Max slope rating, platform uphill (gradeability):

4WD: 45% (24°)



Max slope rating, platform downhill (gradeability):

4WD: 30% (17°)



Max side slope rating:

4WD: 17% (10°)

Note: identify the allowable range of slope and side slope rating. All ratings for Gradeability and Sideslope are based upon the machine's main boom being in the stowed position, fully lowered and retracted.

⚠ WARNING

Do not drive with main boom out of transport mode except on a smooth, firm and level surface.

To avoid loss of travel control or upset on grades and side slopes, do not drive machine on grades or side slopes exceeding those specified on machine nameplate.

Do not drive on side slopes which exceed 5 degrees with platform elevated, do not drive on side slopes which 24 degrees in stowed position.

The user should confirm the control of driving direction before driving.

Be extremely careful when driving in reverse and at all times when driving with platform elevated.

4.2.2.1 Traveling forward and reverse

- a) At Platform Controls, pull out Emergency Stop switch, start the engine, and activate footswitch.



- b) Position DRIVE/STEER control to “FORWARD” OR “REVERSE” hold for duration of forward or reverse travel desired.



The machine is equipped with travelling direction indicator lights. The indicator lights on platform console to inform that the main boom is over rear axle, and steer and drive controls will move in opposite direction other than the direction indicated on machine placards.



If the indicator is illuminated, operate the Drive function in the following manner:

- c) Check blue and yellow arrow on platform control panel and on chassis match or not, confirm the travelling direction.

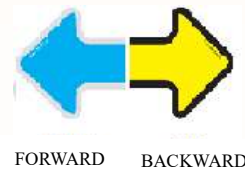

- d) Toggle and loosen travelling direction confirmation switch. Operate the handle to drive as needed within 5 seconds.

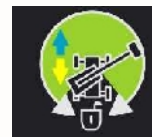

4.2.2.2 Steering

- a) At Platform Controls, pull out Emergency Stop switch, start the engine, and activate footswitch.



- b) Position the traveling/steering handle to the left or right side to turn wheel left or right, accordingly.

4.2.2.3 Driving

- a) Press down the foot switch.
- b) Increase speed: slowly move the drive control handle off center.
- c) Decrease speed: slowly move the drive control handle toward center.
- d) Return the control handle to center or release the foot switch.

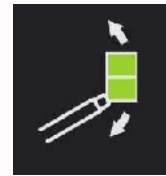

4.2.3 Platform leveling



Only use the platform leveling function for slight leveling of the platform when the platform is in low position. Incorrect use could cause the load/occupants to shift or fall. Failure to do so could result in serious injury.

Before platform level adjustment, identify the position of the platform.

To Level Up or Down –Position the platform/Level control switch Up or Down and hold until the platform is level.

4.2.4 Platform Rotation

To rotate the platform to the left or right, use the Platform Rotate control switch to select the direction and hold until desired position is reached.



Do not swing or raise upper boom above horizontal when machine is out of level.

Do not use the tilt alarm as a level indicator for the chassis.

To avoid tip over, lower platform to ground level. Then drive machine to a level surface before raising upper boom.

To avoid serious injury, do not operate machine if any control lever or toggle switch controlling platform movement does not return to the Off or Neutral position when released.

If the platform does not stop when a control switch or lever is released, remove foot from footswitch or use emergency stop switch to stop the machine.

4.2.5 Turntable Slewing



When swinging the turntable make sure there is ample room for the main boom to clear surrounding walls, partitions and equipment.

Move the control handle on the platform or the control switch on ground to the



'Left' or 'Right' and the turntable will rotate left or right.

4.2.6 Raising and lowering the main boom

If necessary, place the main boom lift handle on the platform or the main boom lift switch on the ground in the 'up' or 'down' position to operate the boom up and boom down functions until the desired height is reached.



4.2.7 Telescoping the main boom

Move the telescoping switch to EXTEND or RETRACT position, the main boom could extend or retract.



4.2.8 Raising and lowering the jib

To raise or lower the tower boom, position the Tower Boom Lift to Up or Down until the desired height is reached.



4.2.9 Emergency stop

Push in the red 'Emergency Stop' button on Ground or Platform Controls to off position to shut off all the functions. Repair any function that operates when red Main Power Switch Button and Emergency Stop button are pushed in at the same time.



4.2.10 Auxiliary power



When operating on auxiliary power, do not operate more than one function at a time.

Compound operation is beyond the capability of auxiliary pump motor.

A toggle type auxiliary power control switch is located on the platform control station and another is located on the ground control station. Operation of either switch turns on the electrically driven auxiliary hydraulic pump. This should be used in case of failure of the main power plant. The auxiliary pump will operate main boom lift, telescope, turntable rotate, jib lift, platform level and platform swing.

Activating from the Platform Control Station:

- a) Turn Platform/Ground Select switch to Ground.

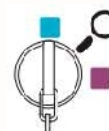

- b) Pull the Power/Emergency Stop switch to On.
- c) Position Auxiliary Power switch to On and hold.



- d) Depress and hold footswitch.
- e) Operate appropriate control switch, lever or controller for desired function and hold.
- f) Release Auxiliary Power switch, selected control switch, level or controller, and footswitch.
- g) Position Power/Emergency Stop switch to Off.

Activating from the Ground Control Station:

- a) Position Platform/Ground select Key Switch to Ground.
- b) Pull the Power/Emergency Stop switch to ON.
- c) Position Auxiliary Power switch to On and hold.
- d) Operate appropriate control switch, lever or controller for desired function and hold.
- e) Release Auxiliary Power switch, and appropriate control switch or controller.
- f) Position Power/Emergency Stop switch to Off.



4.2.11 Shut down and park

- a) Drive machine to a protected area.
- b) Assure main boom is fully retracted and lowered over rear (Drive) axle.
- c) Remove all load and allow engine to operate 3-5 minutes at idle to permit reduction of engine internal temperatures.
- d) At Ground Controls, turn Key Select switch to (center) Off Position, Power/Emergency Stop switch (down) to Off. Remove key.
- e) All access panels and doors closed and secured.
- f) Cover Platform Control console to protect instruction placards, warning decals and operating controls from hostile environment.

4.3 Transport and Lifting

Observe and Obey:

ZOOMLION provides this securement information as a recommendation. Drivers are solely responsible for making sure machines are properly secured and the correct trailer is selected pursuant to CHINA Department of Transportation regulations, other localized regulations, and their company policy.

ZOOMLION customers needing to containerize any lift or ZOOMLION product should source a qualified freight forwarder with expertise in preparing, loading and securing construction and lifting equipment for international shipment.

Only qualified aerial lift operators should move the machine on or off the truck.

The transport vehicle must be parked on a level surface.

The transport vehicle must be secured to prevent rolling while the machine is being loaded.

Be sure the vehicle capacity, loading surfaces and chains or straps are sufficient to withstand the machine weight. ZOOMLION lifts are very heavy relative to their size. See the serial label for the machine weight.

Be sure the machine is on a level surface or secured before releasing the brake.

Do not drive the machine on a slope that exceeds the uphill, downhill or side slope rating. See Driving on a Slope in the Operating Instructions section.

If the slope of the transport vehicle bed exceeds the maximum slope rating, the machine must be loaded and unloaded using a winch as described in the brake release operation.

4.3.1 Release brake when towing

- a) Chock the wheels to prevent the machine from rolling.
- b) Release the wheel brakes by turning over all four drive hub disconnect caps.
- c) Be sure the winch line is properly secured to the drive chassis tie points and the path is clear of all obstructions.
- d) Reverse the procedures described to re-engage the brakes.

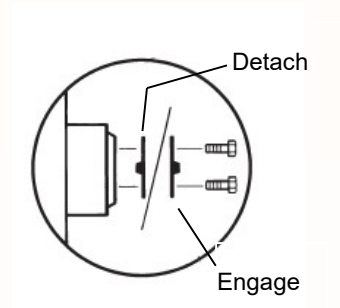

Note: machine traction is not recommended. If the machine must be towed, the speed must not exceed 3.2 km/h(1.99mph).Securing to Truck or Trailer for Transit.

Always use the turntable rotation lock pin each time the machine is transported.

Sequence 1 turntable rotation lock pin.

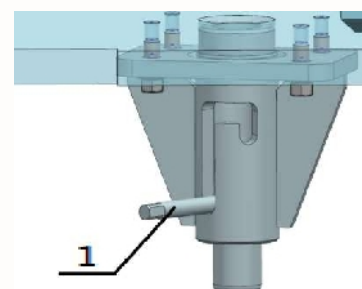

Turn the key switch to the off position and remove the key before transporting.

Inspect the entire machine for loose or unsecured items.

4.3.2 Lifting

- a) See serial label and ‘Technical Parameters’ section in this manual for specific machine weight and total weight of the machine.
- b) Place the boom in the stowed position.
- c) Remove all loose items from the machine.
- d) Properly adjust the rigging to prevent damage to the machine and so the machine remains level.

4.3.3 Securing the chassis

- a) Use chains of ample load capacity.
- b) Use a minimum of 4 chains.
- c) Adjust the rigging to prevent damage to the chains.

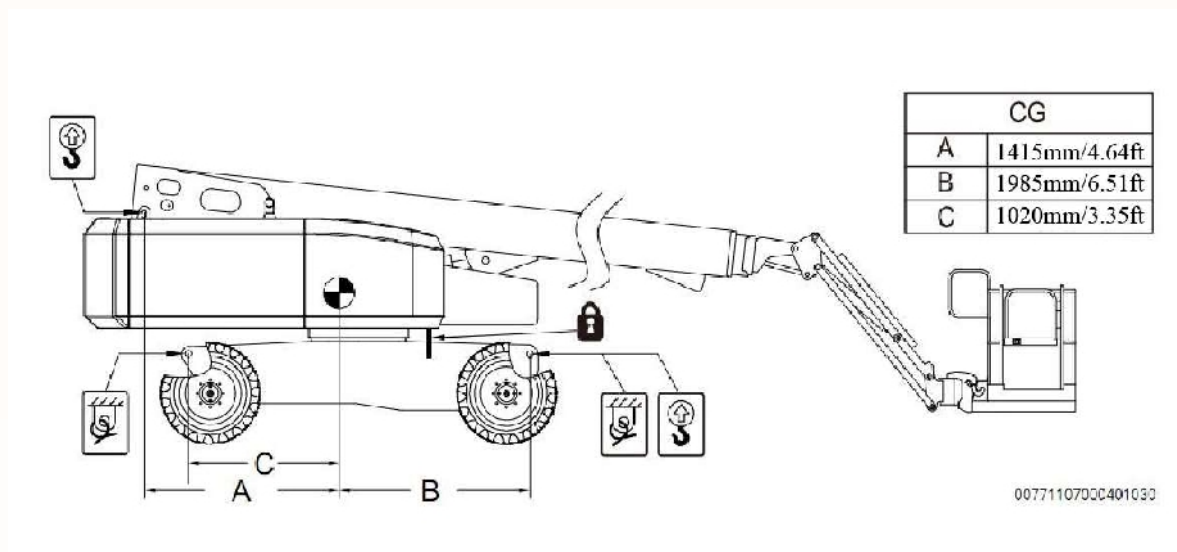

Figure 4-1 Lifting and Securing Instructions

4.3.4 Securing the platform

- a) Be sure the boom and the platform are in stowed position.
- b) Use the straps between the platform rotator (see Figure below) and platform base to secure the platform.
- c) Do not use excessive downward force when securing the boom section.

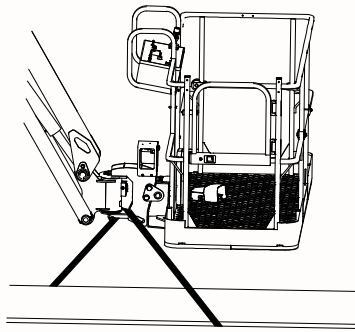

Figure 4-2 Securing the Platform

- d) Use a cable tie or rope to secure the slider to the upper square tube of the work platform to prevent the slider from bumping during transportation.

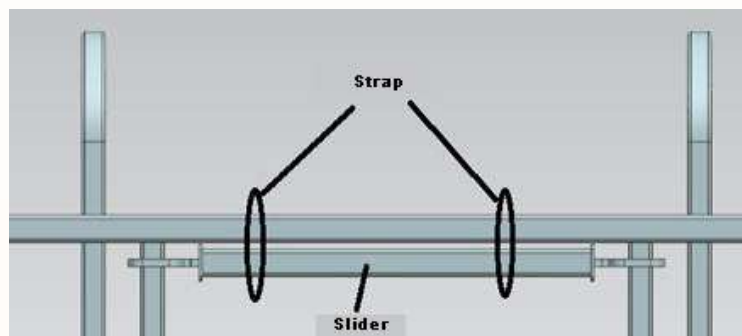
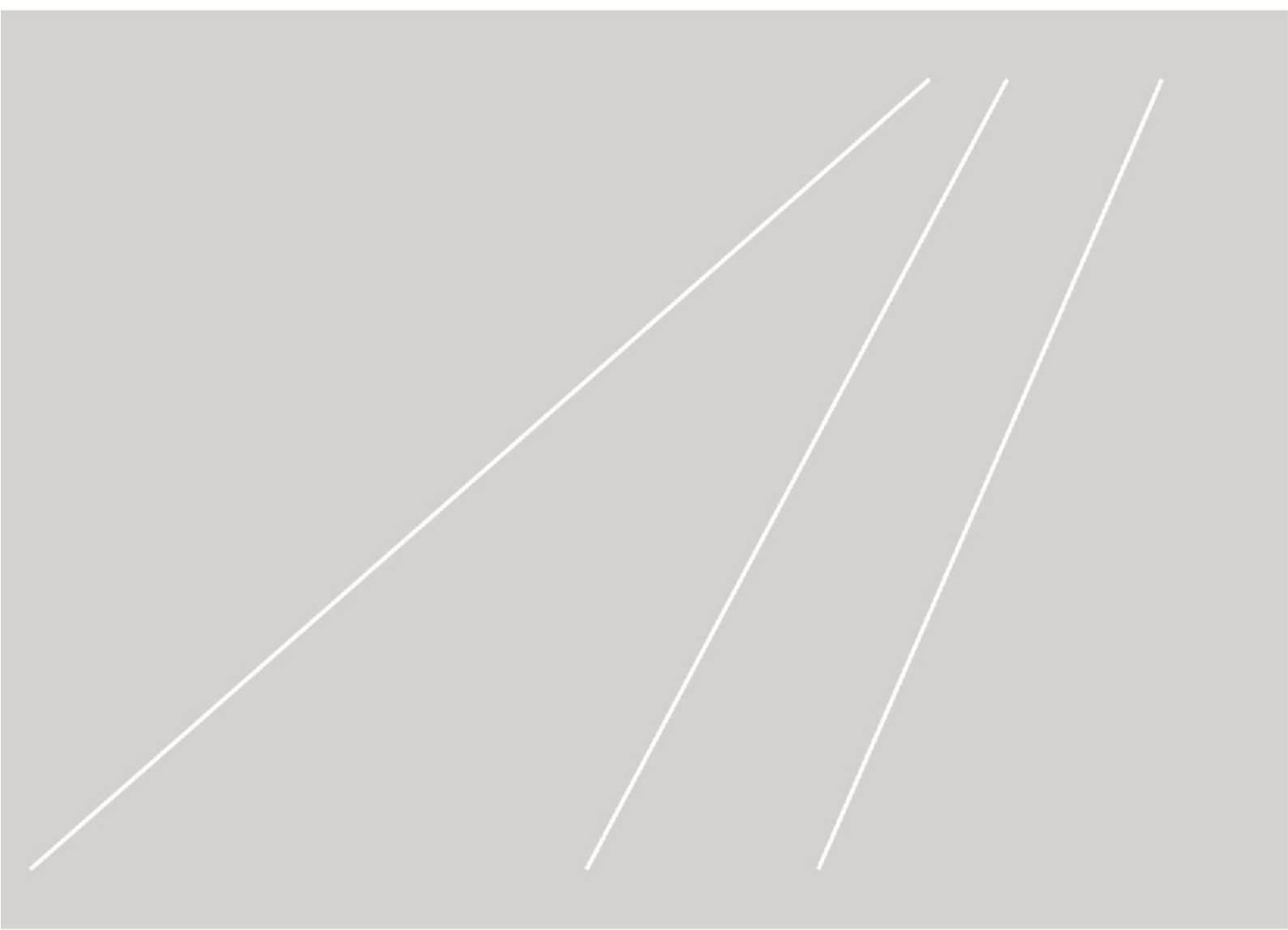

Figure 4-3 Securing the Platform

ZOOMLION

Operation and Safety Manual

Section 5 Maintenance



SECTION 5 MAINTENANCE

5.1 General



Observe and Obey:

Only routine maintenance items specified in this manual shall be performed by the operator.

Scheduled maintenance inspections shall be performed by qualified service technicians, according to the manufacturer's specifications and the requirements listed in the responsibilities manual.

Disposal of materials should be according to the regulations of government and relevant environmental protection administration.

Use only ZOOMLION approved replacement parts. ZOOMLION assumes no responsibility for hazards occurred to equipment and personnel caused by the use of unauthorized parts.

5.1.1 Maintenance symbols legend

The following symbols have been used in this manual to help communicate the intent of the instructions. When one or more of the symbols appear at the beginning of a maintenance procedure, it conveys the meaning below.



Indicates that tools will be required to perform this procedure.



Indicates that new parts will be required to perform this procedure.



Indicates that a cold engine is required before performing this procedure.

5.1.2 Pre-start inspection

- a) Be sure operator's, safety, and responsibilities manuals are complete, legible, and in the storage container located on the machine.
- b) Be sure all decals are in place and legible.
- c) Check for hydraulic oil leaks and proper oil level. Add oil if needed. See Maintenance section.
- d) Check for battery fluid leaks and proper fluid level. Add distilled water if needed after battery charged.

Check the following components or areas for damage, improperly installed, or missing parts and

unauthorized modifications:

- 1) Electrical components, wiring, and electrical cables.
- 2) Hydraulic hoses, fittings, cylinders, and manifolds.
- 3) Drive motor/motor.
- 4) Wear pads.
- 5) Tires and wheels.
- 6) Limit switches and horn.
- 7) Alarm and indicator (if equipped) .
- 8) Nuts, bolts and other fasteners.
- 9) Brake release unit.

5.1.3 Maintenance hazards

- a) Shut off power to all controls and ensure that all moving parts are secured from inadvertent motion prior to performing any adjustments or repairs.

Never work under an elevated platform until it has been fully lowered to the full down position, if possible, or otherwise supported and restrained from movement with appropriate safety props, blocking, or overhead supports.

- b) Do not attempt to repair or tighten any hydraulic hoses or fittings while the machine is powered on or when the hydraulic system is under pressure.
- c) Always relieve hydraulic pressure from all hydraulic circuits before loosening or removing hydraulic components.

Do not use your hand to check for leaks. Use a piece of cardboard or paper to search for leaks. Wear gloves to help protect hands from spraying fluid.



5.1.4 Body injury hazard

Do not operate a machine with a hydraulic oil or air leak. An air leak or hydraulic leak can penetrate and/or burn skin. During or after a period of running of the hydraulic system, the parts may produce high surface temperature, and improper contact will cause burn to skin. Overhauling or adjusting any part of hydraulic system can cause serious injuries. Only trained maintenance personnel are allowed to repair or adjust the hydraulic system.

Suggestion: access by the operator is only advised when performing a pre-operation inspection. All covers must remain closed and secured during operation.

5.2 Power and Hydraulic System Maintenance

5.2.1 Check the engine oil level



Maintaining the engine coolant at the proper level is essential to engine service life. Improper coolant level will affect the engine’s cooling capability and damage engine components.

Note: check the oil level with the engine off. Check the oil level dipstick. Add oil as needed.

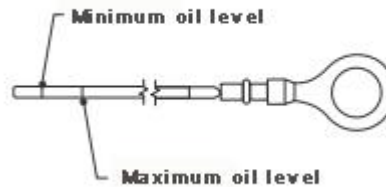

Table 5-1 Refuel condition

DEUTZ D447L4/404D-22t Engine	
Type	Environmental Temperature
CI-4 20W-40	Above -15°C/ Above 5°F
CI-4 15W-40	(-20 ~ -15) °C/ (-4 ~ 5) °F
CI-4 10W-40	(-25 ~ -20) °C/ (-13 ~ -4) °F
CI-4 5W-40	(-30 ~ -25) °C/ (-22 ~ -13) °F
CI-4 0W-40	(-35 ~ -30) °C/ (-31 ~ -22) °F

5.2.2 Diesel requirements

Good engine performance depends on the quality of fuel. Benefits of using quality fuel: long engine life and acceptable exhaust emission levels.

The minimum diesel fuel requirements for the engine are shown in the table below.

Table 5-2 Fuel Requirement

DEUTZ D447L4/404D-22t Engine	
Type	Environmental Temperature
-50# Stage IV (China) Diesel	(-44 ~ -29) °C / (-47 ~ -20) °F
-35# Stage IV (China) Diesel	(-29 ~ -14) °C / (-20 ~ 7) °F
-20# Stage IV (China) Diesel	(-14 ~ -5) °C / (7 ~ -23) °F
-10# Stage IV (China) Diesel	(-5 ~ 4) °C / (23 ~ -39) °F
0# Stage IV (China) Diesel	(4 ~ 8) °C / (39 ~ -46) °F
5# Stage IV (China) Diesel	Above 8°C / Above 46°F

5.2.3 Check the engine coolant level



Maintaining the engine coolant at the proper level is essential to engine service life. Improper coolant level will affect the engine’s cooling capability and damage engine components. Daily checks will allow the inspector to identify changes in coolant level that might indicate cooling system problems.



Burn hazards

Beware of hot engine parts and coolant. Touching hot engine parts or coolant can cause serious scald.



Burn hazards

Do not remove radiator cover while the engine is running. Contact with pressurized coolant can cause serious burns. Remove the radiator cover after the engine is cool.

Check the coolant level in recycle tank. Add coolant as required. The level should be visible at MAX mark of the coolant recycle tank or at level gauge. Do not overfill the coolant.

5.2.4 Check hydraulic oil

a) Hydraulic Oil Level



Maintaining the hydraulic oil at the proper level is essential to machine operation. Improper hydraulic oil levels can damage hydraulic components. Daily checks allow the inspector to identify changes in oil level that might indicate the presence of hydraulic system problems.

Be sure the machine is on a firm and level surface and in stowed position. By observing oil level in hydraulic oil tank, the hydraulic oil level after excluding air in the hydraulic system should reach the maximum scale mark on the hydraulic oil tank, and not be higher than bottom of the oil tank cap (different models have different maximum scale).

Add oil as needed. Do not overfill.



b) Hydraulic Oil Capacity

Table 5-3 Capacity

Model	ZT68J	ZT68J
Hydraulic tank	150 L	39.63 (us gal)
Hydraulic system (including tank)	180 L	47.55 (us gal)

c) Hydraulic Oil Specification

Please refer to the Table 5-4 below for the recommended type and model of hydraulic oil — Technical Parameters of Hydraulic Oil. Please select proper hydraulic oil according to the specific application environment of the equipment. For special environment or special requirements of users, please contact ZOOMLION or the hydraulic oil manufacturer.

Note: Do not mix oils of different brands or types, as they contain different additives which may cause negative effects. If mixing of hydraulic oils is unavoidable, permission must be obtained from the hydraulic oil manufacturer. After-sales service of ZOOMLION does not cover machine malfunction caused by hydraulic oil mixing.

Table 5-4 Technical Parameters of Hydraulic Oil

Technical Parameters	Mobil SHC Aware H 32 (Eco-Friendly)	Mobil DTE 10 Ultra 22	Mobil DTE 10 Ultra 32	Mobil DTE 10 Ultra 46	Caltex Rando MV 22	Caltex Rando MV 32	Kunlun 10 aviation hydraulic fluid (ground)	Great Wall L-HV 32	Great Wall L-HV 46	Great Wall 4632 grease non-flammable hydraulic oil N32 (Eco-Friendly)
ISO Viscosity Grade	32	22	32	46	22	32	10	32	46	32
Pour Point °C	-30°C /-22°F	-54°C /-65°F	-54°C /65°F	-45°C /-49°F	-36°C /-33°F	-36°C /33°F	-50°C /-58°F	-39°C /38°F	-37°C /-35°F	-20°C /-4°F
Flash Point °C	185°C /365°F	224°C /435°F	250°C /482°F	232°C /450°F	190°C /374°F	210°C /410°F	92°C /198°F	231°C /448°F	240°C /464°F	270°C /518°F
Motion Viscosity (40 °C)	32cSt	22.4 cSt	32.7 cSt	45.6 cSt	22.5 cSt	33.5 cSt	10cSt (50°C)	33.4 cSt	48.7 cSt	28.8-35.2cSt
VI viscosity index	140	164	164	164	155	155	150	150	150	180

d) Hydraulic Oil Viscosity and Temperature Limit

Proper use of hydraulic oil: please note the corresponding oil viscosity and temperature limit. Under normal conditions, the recommended oil temperature should be controlled at 30 °C/86°F to 60 °C /140°F . The oil temperature affects the oil viscosity and the thickness of the oil film. High temperatures also shorten the service life of oil seals and other rubber components, and the oil also

evaporates and oxidizes.

Pre-delivery of the machine, specific model of hydraulic oil shall be added as required by customer. If machine operating environment temperature is beyond the temperature limit of the hydraulic oil, different hydraulic oil suited to the actual conditions shall be used in time. On account of the safety of machine components and work efficiency, it is advisable that the starting temperature should be 25 °C/77°F higher than the pour point of hydraulic oil.

e) Hydraulic oil replacement

We suggest that changing time of the hydraulic oil is as follows:

A) First changing: operating for 500 hrs after commissioning.

B) Second and subsequent changing: every 2,000 hrs of operation or twice a year.

The above recommended intervals are suitable for most applications. Higher temperatures and pressures will shorten the oil's service life, so the hydraulic oil should be changed sooner than the recommended. For small load work, the oil change time can be extended.

Cleanliness of the hydraulic oil upon delivery is NAS9 (ISO4406 18/15), and for normal operation, the cleanliness should not be lower than NAS10 (ISO4406 19/16). We suggest that the hydraulic oil should be checked every 6 months, and the oil should be sampled at least once upon the time for oil changing. The oil sample can be sent to the hydraulic oil manufacturer or qualified third-party testing agency for analysis and to determine whether it is still usable.

Changing Oil Return Filter

The oil return filter is recommended to be changed every 1000 hrs of operation or every half a year, whichever comes first. Proper filter condition is essential to good machine performance and service life. Dirty or clogged filters will affect machine performance and damage components. Under hostile environment and bad operating conditions, the filter should be checked and replaced more frequently.



5.3 Battery Maintenance

Battery Inspection



Proper battery condition is essential to good machine performance and operational safety. Improper fluid levels or damaged cables and connections can result in component damage and hazardous conditions.

Note: this inspection is not required for machines with sealed or non-maintainable batteries.

Check electrolyte level of the battery every two weeks. Fully charge the battery before adding water. If

the electrolyte level is much higher than the plate, then no need to add water.



Electrocution hazard

Contact with hot or live circuits may result in death or serious injury. Remove all rings, watches and jewelry.



Body injury hazard

Batteries contain acid. Avoid spilling or contacting battery acid. Neutralize battery acid spills with baking soda and water.

Note: the battery should be fully charged before this inspection.

- a) Only qualified riggers should rig the machine.
- b) Only certified crane operators should lift the machine and only in accordance with the applicable crane regulations.
- c) Be sure that the battery hold-down brackets are in place and secure.

Note: adding terminal protectors and a corrosion preventative sealant will help eliminate the corrosion on the battery terminals and cables.

5.4 Regular Maintenance

Maintenance performed quarterly, annually and every two years must be completed by a person trained and qualified to perform maintenance on this machine according to the procedures found in the service manual for this machine.

Machines that have been out of service for more than three months must receive the quarterly inspection before they are put back into service.

Note: lubrication intervals are based on machine operation under normal conditions. For machines used in multi-shift operations or exposed to hostile environments or conditions, lubrication frequencies must be increased accordingly.

5.4.1 Swing drive

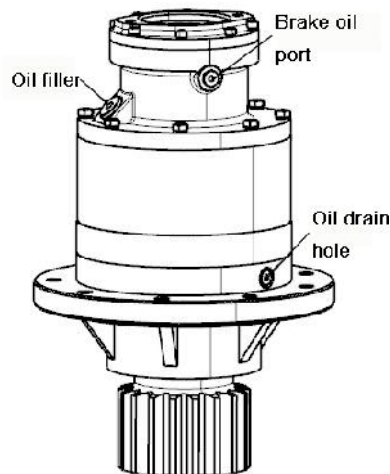

Lube Point(s) –Replaceable Filter.

Battery Level: As required.

Lube Point(s) –Changcheng 7408B-1 Gear Grease.

Interval –Every 3 months or 150 hours.

Note: Apply grease and rotate in 90 degree intervals until bearing is completely lubricated.



Do not over-lubricate the bearings, otherwise it will cause damage to outside seal of casing.

5.4.2 Hydraulic reservoir

Capacity: 100-135L/26.4-35.7 us gal.

Interval –Check level daily; change every 2 years or 2,000 hours of operation.

Note: on new machines, those recently overhauled, or after changing hydraulic oil, operate all system a

minimum of two complete cycles and recheck oil level in reservoir.

a) Hydraulic Return Filter



Maintenance Point(s) –Replaceable Element.

Interval –After 50 hours of operation for the first replacement, and change it every 6 months or 1000 hours of operation afterwards.

b) Hydraulic Tank Breather



Maintenance Point(s) –Tank Breather.

Interval –After 50 hours of operation for the first replacement, and change it every 6 months or 500 hours of operation afterwards.

Note: remove wing nut and cover to replace. Under certain conditions, it may be necessary to replace on a more frequent basis.

5.4.3 Drive hub



Lube Point(s) –Level/Fill Plug.

Battery Level: 1L/0.26 us gal.

Type: GL-5 80W90 Industrial Gear Oil for Close Motor.

Interval –Check level every 3 months or 150 hours of operation; change every year or 2000 hours of operation.

5.4.4 Replace engine oil -Deutz D447L4



Maintenance Point(s) –Fill Cap/Spin-on Element.

Battery Level: about 8.9 L/2.35 us gal.

Lube Point(s) –Engine oil.

Interval –Every 6 months or 500 hours of operation.

Note: check level daily/ Change in accordance with engine manual.

5.4.5 Fuel filter Deutz D447L4

a) First class fuel filter



Maintenance Point(s) –Replaceable Element.

Interval –Check water drainage daily; change every 6 months or 500 hours of operation.

b) Second class fuel filter



Maintenance Point(s) –Replaceable Element.

Interval –Every 6 months or 500 hours of operation.

c) Third class fuel filter



Maintenance Point(s) –Replaceable Element.

Interval –Check water drainage daily; change every 6 months or 500 hours of operation.

5.4.6 High pressure filter



Maintenance Point(s) –Replaceable Element.

Interval –change every year or 2000 hours of operation.

5.4.7 Air filter



Maintenance Point(s) –Replaceable Element.

Interval –Every 6 months or 500 hours of operation or as indicated by the condition indicator.

Note: check dustproof valve everyday.

5.4.8 Engine coolant



Maintenance Point(s) –Add/replace anti-freezing solution.

Battery Level: about 11.3 L/2.99 us gal.

Interval –Check oil level daily, change every 2000 hours or one year (whichever come first).

5.5 Tire and Wheel

5.5.1 Tire replacement

ZOOMLION recommends a replacement tire be the same size, ply and brand as originally installed on the machine. Please refer to the ZOOMLION Parts Manual for the part number of the approved tires for a particular machine model. If not using a ZOOMLION approved replacement tire, we recommend that replacement tires have the following characteristics:

- a) Equal or greater ply/load rating and size of original.
- b) Tire tread contact width equal or greater than original.
- c) Wheel diameter, width, and offset dimensions equal to the original.
- d) Approved for the application by the tire manufacturer (including inflation pressure and maximum tire load).

Unless specifically approved by ZOOMLION do not replace a foam filled tire assembly with a pneumatic tire. When selecting and installing a replacement tire, ensure that all tires are inflated to the pressure recommended by ZOOMLION. Due to size variations between tire brands, both tires on the same axle should be the same.

5.5.2 Wheel and tire replacement

The rims installed on each product model have been designed for stability requirements which consist of track width, tire pressure, and load capacity. Size changes such as rim width, center piece location, larger or smaller diameter, etc., without written factory recommendations, may result in an unsafe condition regarding stability.

5.5.3 Wheel installation

It is extremely important to apply and maintain proper wheel mounting torque.



Wheel nuts must be installed and maintained at the proper torque to prevent loose wheels, broken studs, and possible dangerous separation of wheel from the axle. Be sure to use only the nuts matched to the cone angle of the wheel.

Tighten the lug nuts to the proper torque to prevent wheels from coming loose. Use a torque wrench to tighten the fasteners. If you do not have a torque wrench, tighten the fasteners with a lug wrench, then immediately have a service garage or dealer tighten the lug nuts to the proper torque. Over-tightening will result in breaking the studs or permanently deforming the mounting stud holes in the wheels. The proper procedure for attaching wheels is as follows:

- a) Start all nuts by hand to prevent cross threading. DO NOT use lubricant on threads or nuts.
- b) Tighten nuts in the following sequence.

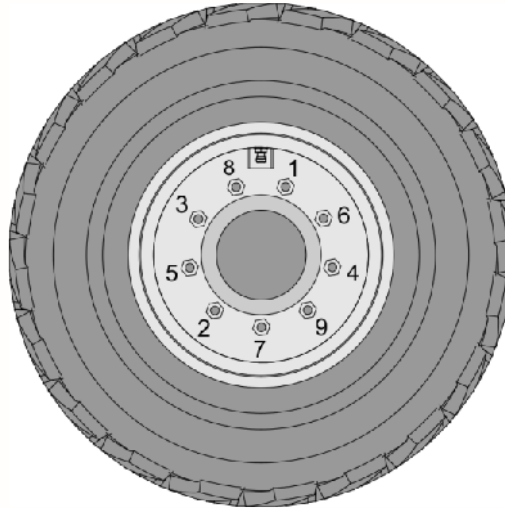

- c) The tightening of the nuts should be done in stages. Following the recommended sequence, tighten nuts per wheel torque.

Table 5-5 Wheel Torque Table

Torque Sequence		
1st Stage	2nd Stage	3rd Stage
75 Nm/55ft·lb	150Nm/111ft·lb	310 Nm/229ft·lb

- d) Wheel nuts should be torqued after first 50 hours of operation and after each wheel removal. Check and torque every 3 months or 150 hours of operation.

ZOOMLION

Operation and Safety Manual

Section 6 Storage and Ex-Factory Test

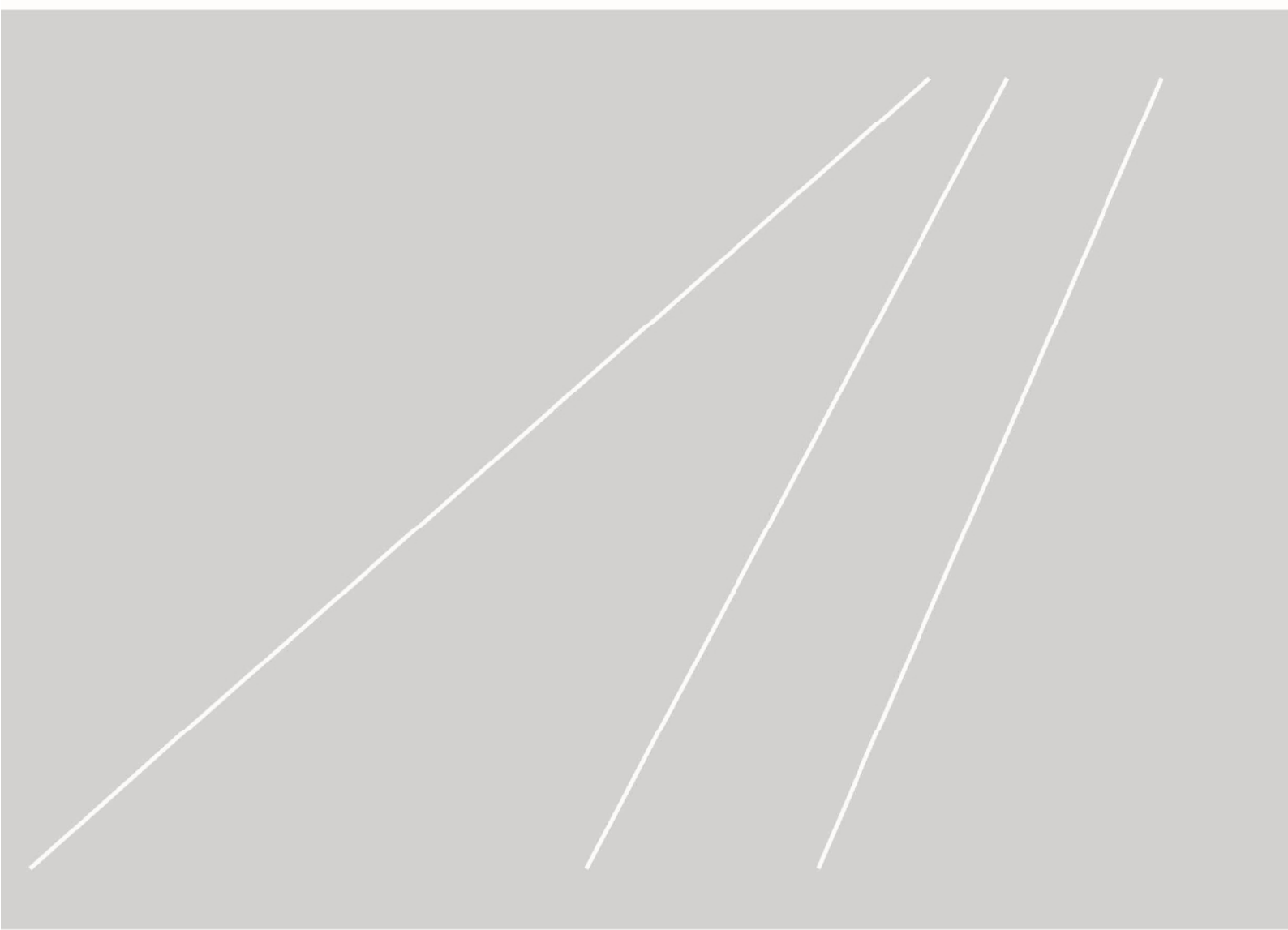

SECTION 6 STORAGE AND EX-FACTORY TEST

6.1 Storage Conditions

Ambient temperature for machine storage and transportation should be between -20 °C /-4°F and 40 °C/104°F, with relative humidity not greater than 85% and 100% only for short-term.

6.2 Ex-factory Test Items

Machine must complete testing items in the following table before delivery:

Table 6-1 Testing items before delivery

Tests Items	Load Testing		Testing Movement
Overload Test	125%	567kg/1250lb	Lift the platform within the range of motion
Functional Test	110%	330kg/727lb	Traveling & Platform Lifting
Braking Test	100%	454kg/1000lb	Max Speed of Forward & Reverse Traveling

ZOOMLION

Operation and Safety Manual

Section 7 Technical Parameter

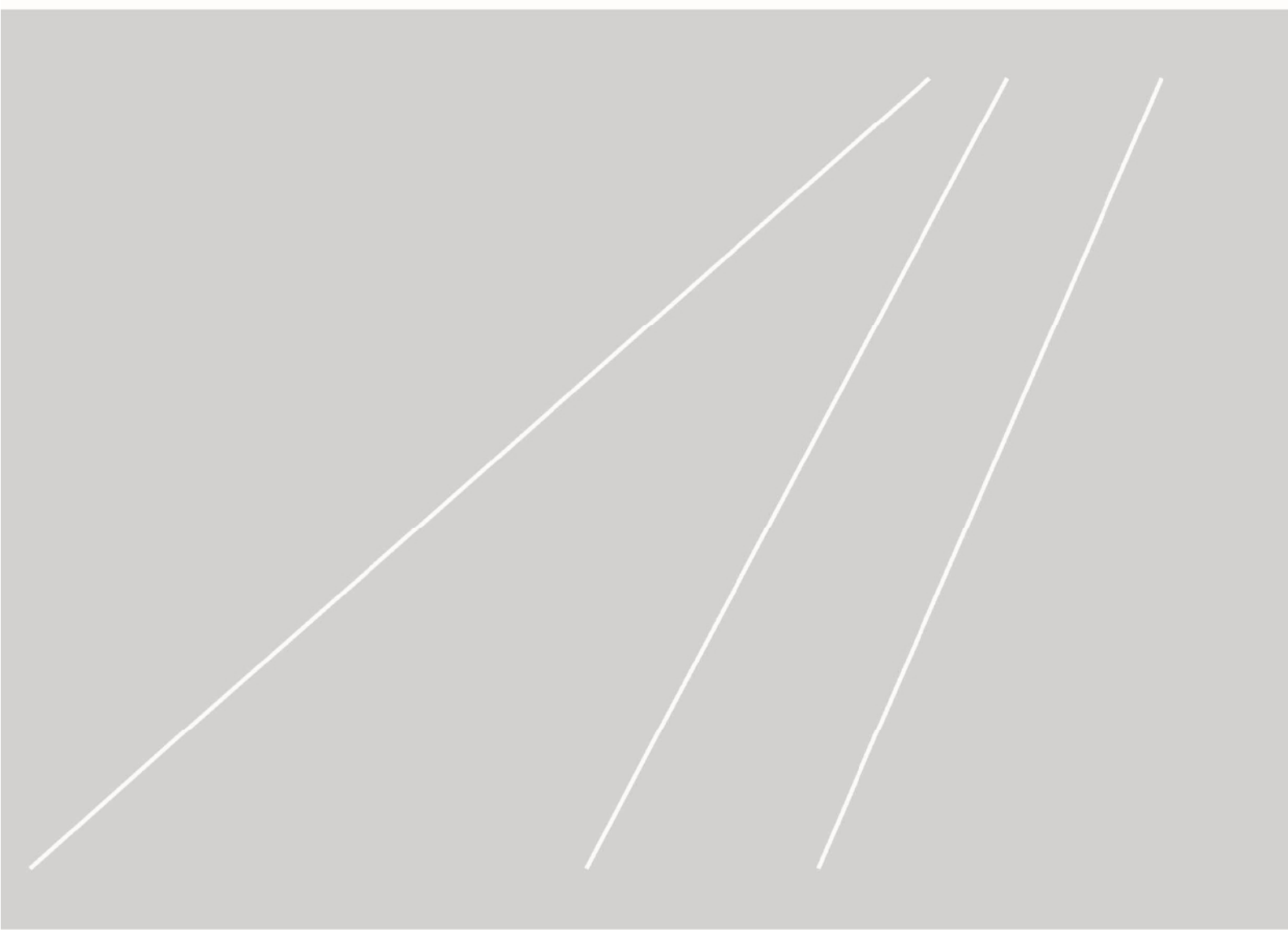

SECTION 7 TECHNICAL PARAMETER

Table 7-1

Model		ZT68J	
Size	Work Height	22.75 m	74ft8in
	Platform Height	20.75 m	68ft
	Horizontal Outreach	17.4m	57ft1in
	Overall Length (Stowed)	10.36m	33ft12in
	Overall Width (Stowed)	2.49m	8ft2in
	Overall Height (Stowed)	2.78m	9ft
	Platform Length	2.44m	8ft
	Platform Width	0.91m	3ft
	Wheelbase	2.52m	8ft3in
	Ground Clearance	0.42m	1ft4in
Performance	Platform Capacity (Restricted/Unrestricted)	300/454 kg	660/1000lb
	Drive Speed	6 km/h	3.73mph
	Gradeability	45% (24°)	45% (24°)
	Turning Radius (Inside)	2.4 m	7ft10in
	Turning Radius (Outside)	5.4 m	17ft8in
	Turntable Swing	360 ° continuous	360 ° continuous
	Platform Rotation	±90°	±90°
	Jib Rotation	-60°~ 75°	-60°~ 75°
	Max. Working Slope	3°	3°
	Max. Wind Speed	12.5 m/s	28mph
Power	Engine	DeutzD447L4/Perkins404 D-22T	DeutzD447L4/Perkins404 D-22T
	Engine Power	36.5/ 36.5/45.4kw	49/ 49/61hp
	Fuel Tank	130 L	34 us gal
	Auxiliary Power	12 V	12 V
	Control Voltage	12 V	12 V
	Hydraulic System Capacity	230 L	60.8 us gal
	Hydraulic Tank Capacity	150 L	39.6 us gal
Tire	Tires Type	355/55D-625 foam filled	355/55D-625 foam filled
Weight	Gross	12200 kg	26896lb

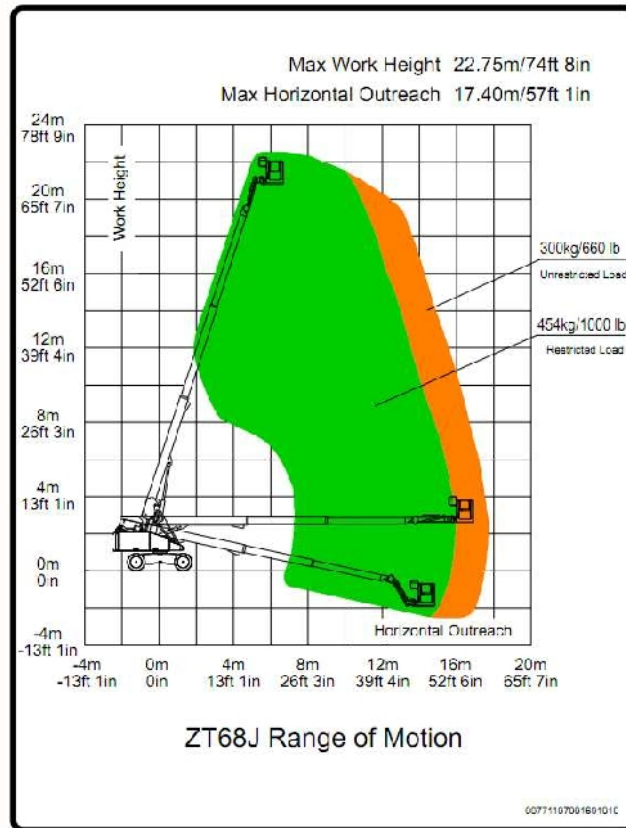

Figure 7-1 ZT68J Range of Motion

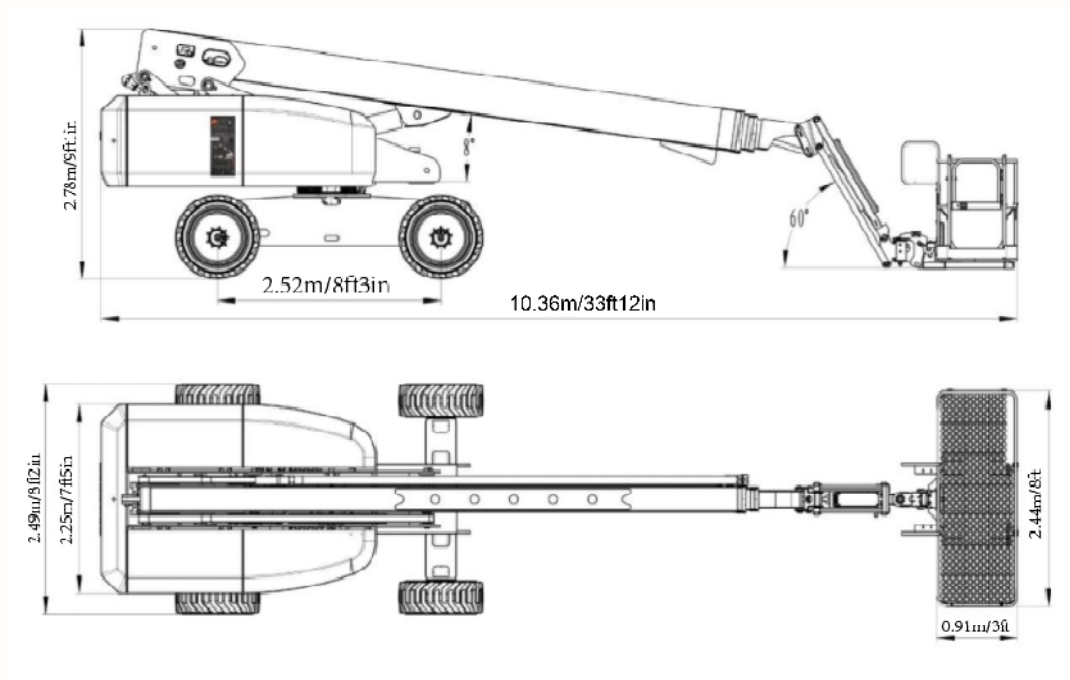

Figure 7-2 ZT68J Dimension when stowed

